



BATHROOM CATALOGUE 2011

BATHTUBS | HYDRO-AIRMASSAGE SYSTEMS | SANITARY WARE

BATHROOM TAPS | STAINLESS STEEL WASHBASINS | BATHROOM ACCESSORIES

SOLAR SYSTEMS | WATERHEATERS - BOILERS

Index



02 - 03

BATHTUBS - HYSROMASSAGE - AIRMASSAGE

04 - 07
08 - 11
12 - 14
15 - 17
18 - 23
24 - 27

ELEGANCIA
ORCHIDEA
ANTHEMIA
IRIDA
VALERIA
ANEMONA

28 - 29

SANITARY WARE

30 - 31
32 - 35
36 - 37
38 - 41
42 - 43
44 - 45
46 - 47
48 - 49

DEKELIA
ERETRIA
ETOLIA, LIDIA, ACTIUM
ELATIA
MILITOS
TROY
WASHBASINS
WCS & URINAL

50 - 55

BATHROOM TAPS

56 - 57

STAINLESS STEEL WASHBASINS

BATHROOM ACCESSORIES

58 - 61
62 - 65

NASHIRA
ZAFIRA

66 - 69

SOLAR SYSTEMS

70 - 71

WATERHEATERS - BOILERS

72 - 74

LOADING SPECIFICATIONS

Acrylic Bathtubs - Hydromassage - Airmassage

PYRAMIS combining high technology with style and comfort, transforms luxury into everyday pleasure in the bathroom.

Through a large variety of bathtubs and hydro-air massage systems of great quality in affordable prices, PYRAMIS offers the choice of what best fits in a bathroom and covers daily hygiene needs at the maximum.

Bathtubs' Technical Specifications

PYRAMIS bathtubs are made of pure acrylic material, 4-5mm thick. It is hypoallergic, smooth and warm to touch and features high insulating characteristics, maintaining the water temperature for longer time. In case it is damaged its repair is very easy to perform by using a special shining cream for acrylic material and water sandpaper. PYRAMIS bathtubs also feature a 16mm base which offers extra stability and durability, that is the reason why they have a 25 year guarantee.

Technical Characteristics Hydromassage

The hydromassage systems are available in 3 types, Turbo, Turbo Plus and ECO. They all have 6 double energy jets (50mm or 65mm) with adjustable flow (2 on the back, 2 on the sides and 2 on the feet). The first two hydromassage types can be combined with an airmassage system.

Turbo Hydromassage System

It includes:

- Air supply tube **Ø16mm**
- Water supply tube **Ø32mm**
- **6** adjustable, double energy jets **50mm**
- 1 absorption inlet **Ø50mm** with filter
- 1 pneumatic switch with special system for air regulation
- 1 thermal switch for motor protection
- 1 air-switch **21A-240V** in the motor
- Dynamic water drainage
- Perimetric base

Turbo Plus Hydromassage System

It includes:

- Air supply tube **Ø20mm**
- Water supply tube **Ø32mm**
- **6** adjustable, double energy jets **50mm**
- 1 absorption inlet **Ø50mm** with filter
- 1 pneumatic switch with special system for air regulation
- 1 thermal switch for motor protection
- 1 air-switch **21A-240V** in the motor
- Dynamic water drainage
- Perimetric base

Airmassage System

It includes:

- 1 blower with heater **800W**
- 1 pneumatic switch
- 1 thermal switch for motor protection
- **10** micro air-jets
- 1 kit of pneumatic switch **21A-240V**

Common Characteristics for Hydromassage Systems

- Motor Power **1HP**
- Voltage **230V-50Hz**
- Pump Flow **21,5m³/h**
- Pump Pressure SPA **13,5m**
- Water Flow Capacity **400lt/min**

ECO Hydromassage System

It includes:

- Motor power: **1HP**
- Voltage: **230V-50Hz**
- Water pump flow: **307lt/min**
- Pump pressure: **12m**
- Technical Characteristics:
- Air supply tube **Ø10mm**
- Water supply tube **Ø32mm**
- **6** adjustable, double energy jets **65mm**
- 1 suction inlet **Ø85mm**
- 1 pneumatic switch On/Off
- 1 air regulator
- 1 thermal switch for motor protection
- 1 air-switch **21A-240V** in the motor
- Dynamic water drainage
- 1 anti-shock pump metal base
- Dynamic water drainage
- Network of PVC piping for air & water

Hydro – Airmassage Accessories



Pneumatic switch



Underwater lighting



Bathtub Handle



Hydromassage & Airmassage Touch Control



Turbo Jet



Chromatotherapy



Hydromassage Touch Control



Jet



Chromatotherapy control panel

Hydromassage Construction

Metallic support system

Every hydromassage has an all-around metallic support system for easier and safer installation. The piping system (made of pool rubber) offers full water drainage through natural flow.

High pressure motor pump

PYRAMIS hydromassage systems are equipped with a pump of high water pressure (motor 1 HP, water flow pump 400lt/min) which is used in SPAs and it has a good function guarantee even for salt water.

Automatic disinfection system with Ozon

PYRAMIS hydromassage systems can facilitate an automatic disinfection system which supplies the ozon through the air circulation of the hydromassage.





elegancia

BATHROOM

Elegancia bathtubs are a centerpiece in the bathroom. With their robust forms and classy design, they bring harmony and elegance to the needs of daily hygiene.

Enjoy one of the four models of the series in different sizes, alone or in combination with a hydromassage and airmassage system Turbo or Turbo Plus.

All four Elegancia bathtubs are heavy duty bathtubs with very thick acrylic material. They feature a double coat of polyester, a cover of grey resin and a base that reaches up to 16mm thickness. Therefore, Elegancia bathtubs respond to the most demanding requirements for:

- **Robust resilience**
- **Total rigidity**
- **Timeless durability**
- **Increased heat insulation**
- **Decreased noise level**



ELEGANCIA 170X70cm



Description	Ar. Number
BATHTUB ELEGANCIA 170X70cm	022214001
BATHTUB ELEGANCIA 170X70cm WITH HYDROMASSAGE TURBO PLUS	185210001
BATHTUB ELEGANCIA 170X70cm WITH HYDROMASSAGE & AIRMASSAGE TURBO PLUS	185250001
PANEL ELEGANCIA 170cm LONG	021600301
PANEL ELEGANCIA 70cm WIDE	021600201

- PROPOSED MOTOR POSITION
- PROPOSED HANDLE POSITION

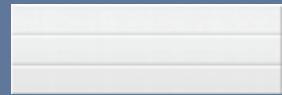
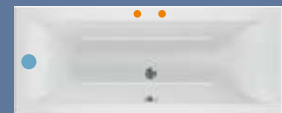

Bathtub Dimensions: 170 x 70cm

Bathtub Net Weight: 33kg
Full Capacity: 285lt

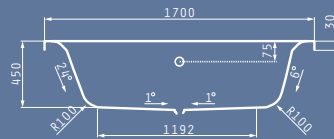
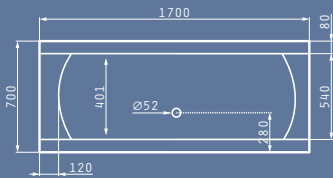

ELEGANCIA 170X80cm



Description	Ar. Number
BATHTUB ELEGANCIA 170X80cm	022214101
BATHTUB ELEGANCIA 170X80cm WITH HYDROMASSAGE TURBO PLUS	185210101
BATHTUB ELEGANCIA 170X80cm WITH HYDRO & AIRMASSAGE TURBO PLUS	185250101
PANEL ELEGANCIA 170cm LONG	021600301
PANEL ELEGANCIA 80cm WIDE	021400401

- PROPOSED MOTOR POSITION
- PROPOSED HANDLE POSITION

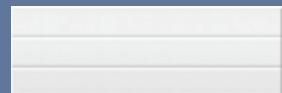
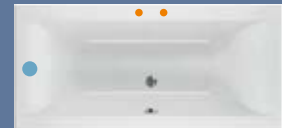

Bathtub Dimensions: 170 x 80cm

Bathtub Net Weight: 35kg
Full Capacity: 320lt

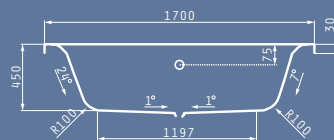
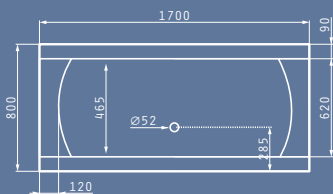

ELEGANCIA 180X80cm



Description	Ar. Number
BATHTUB ELEGANCIA 180X80cm	022214201
BATHTUB ELEGANCIA 180X80cm WITH HYDROMASSAGE TURBO PLUS	185210201
BATHTUB ELEGANCIA 180X80cm WITH HYDRO & AIRMASSAGE TURBO PLUS	185250201
PANEL ELEGANCIA 180cm LONG	021400301
PANEL ELEGANCIA 80cm WIDE	021400401

- PROPOSED MOTOR POSITION
- ALTERNATIVE MOTOR POSITION
- PROPOSED HANDLE POSITION

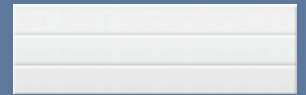
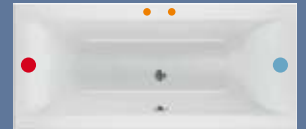

Bathtub Dimensions: 180 x 70cm

Bathtub Net Weight: 39kg
Full Capacity: 335lt

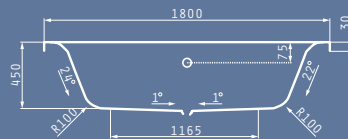
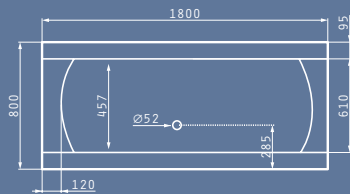

ELEGANCIA 190X90cm



Description	Ar. Number
BATHTUB ELEGANCIA 190X90cm	022214301
BATHTUB ELEGANCIA 190X90cm WITH HYDROMASSAGE TURBO PLUS	185210301
BATHTUB ELEGANCIA 190X90cm WITH HYDRO & AIRMASSAGE TURBO PLUS	185250301
PANEL ELEGANCIA 190cm LONG	021400501
PANEL ELEGANCIA 90cm WIDE	021400601

- PROPOSED MOTOR POSITION
- ALTERNATIVE MOTOR POSITION
- PROPOSED HANDLE POSITION

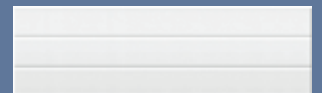
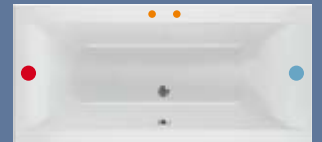

Bathtub Dimensions: 190 x 90cm

Bathtub Net Weight: 42kg
Full Capacity: 410lt

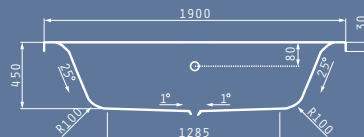
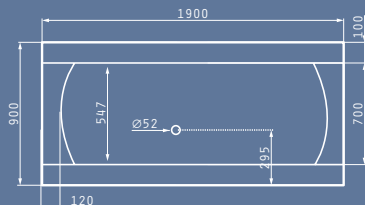

BATHTUB ACCESSORIES & INSTALLATION PARTS

Accessories	Ar. Number
BATH TUB HANDLE	021501601
BATHTUB AUTOMATIC WASTE VALVE	022009901
UNDERWATER LIGHTING	021502801
OZON THERAPY AND SANITATION SYSTEM	021502701
HYDROMASSAGE TOUCH CONTROL	021501901
HYDROMASSAGE & AIR MASSAGE TOUCH CONTROL	021502001
CHROMATOTHERAPY SYSTEM	021503301
ON-OFF CONTROL WITH WATER LEVEL SENSOR	021503601

Installation Parts	Ar. Number
BATHTUB INSTALLATION KIT (WALL MOUNTED)	021501701
STANDARD FEET SYSTEM *	021501001
ACCESS ALUMINUM COVER 45X35cm	021501801



orchidea series

BATHROOM

Five bathtubs of different styles and dimensions offer the appropriate choice for every bathroom.

They combine ergonomic design with advanced quality features. All models are available with hydromassage, in two types and airmassage.

ORCHIDEA 105X105cm



Description	Ar. Number
BATHTUB ORCHIDEA 105X105cm	022213601
PANEL ORCHIDEA 105X105cm	021105501

- PROPOSED MOTOR POSITION
- PROPOSED HANDLE POSITION

Bathtub Dimensions: 105 x 105cm

Bathtub Net Weight: 20kg
Full Capacity: 145lt

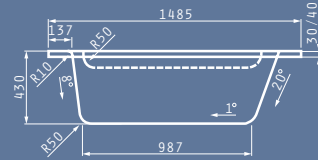
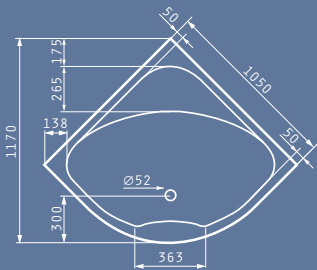

ORCHIDEA 120X120cm



Description	Ar. Number
BATHTUB ORCHIDEA 120X120cm	022213202
BATHTUB ORCHIDEA 120X120cm WITH HYDROMASSAGE TURBO	183012001
BATHTUB ORCHIDEA 120X120cm WITH HYDROMASSAGE TURBO PLUS	183012101
BATHTUB ORCHIDEA 120X120cm WITH HYDRO & AIRMASSAGE TURBO	183113001
BATHTUB ORCHIDEA 120X120cm WITH HYDRO & AIRMASSAGE TURBO PLUS	183113101
PANEL ORCHIDEA 120X120cm	021105002

- PROPOSED MOTOR POSITION
- PROPOSED HANDLE POSITION

Bathtub Dimensions: 120 x 120cm

Bathtub Net Weight: 23kg
Full Capacity: 235lt

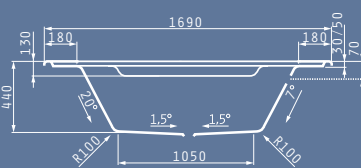
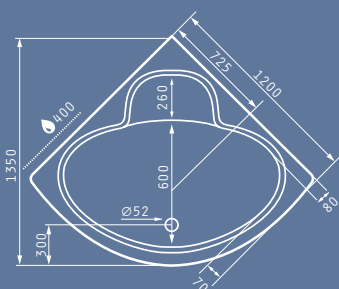

WATER SUPPLY

ORCHIDEA 135X135cm

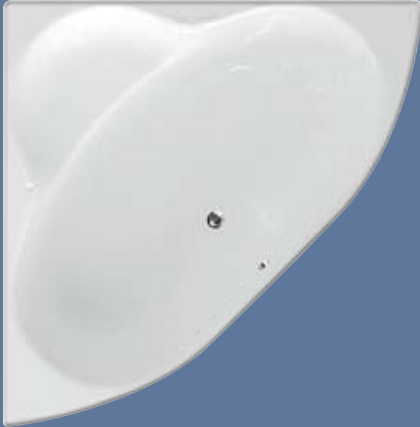

Bathtub Dimensions: 135 x 135cm

Bathtub Net Weight: 23kg
Full Capacity: 235lt

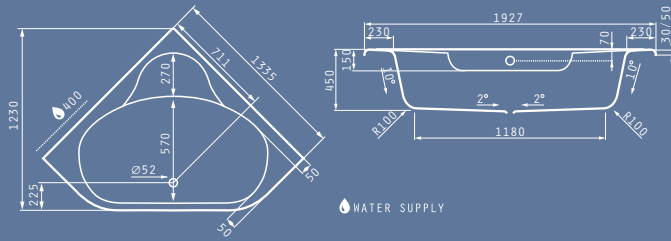

Description	Ar. Number
BATHTUB ORCHIDEA 135X135cm	022213302
BATHTUB ORCHIDEA 135X135cm WITH HYDROMASSAGE TURBO	183012601
BATHTUB ORCHIDEA 135X135cm WITH HYDROMASSAGE TURBO PLUS	183012701
PANEL ORCHIDEA 135X135cm	021105302

- PROPOSED MOTOR POSITION
- ALTERNATIVE MOTOR POSITION
- PROPOSED HANDLE POSITION



ORCHIDEA 140X140cm



Bathtub Dimensions: 140 x 140cm

Bathtub Net Weight: 30kg
Full Capacity: 225lt

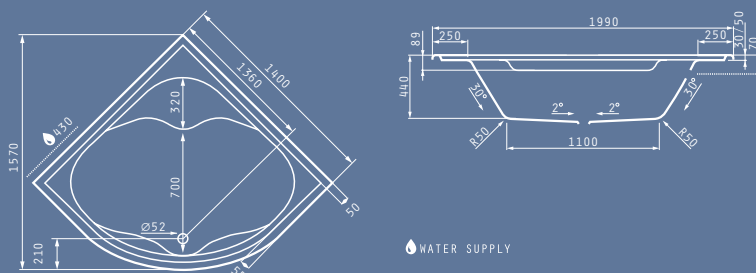

Description	Ar. Number
BATHTUB ORCHIDEA 140X140cm	022210301
BATHTUB ORCHIDEA 140X140cm WITH HYDROMASSAGE TURBO	183012201
BATHTUB ORCHIDEA 140X140cm WITH HYDROMASSAGE TURBO PLUS	183012301
BATHTUB ORCHIDEA 140X140cm WITH HYDRO & AIRMASSAGE TURBO	183113201
BATHTUB ORCHIDEA 140X140cm WITH HYDRO & AIRMASSAGE TURBO PLUS	183113301
PANEL ORCHIDEA 140X140cm	021105101

- PROPOSED MOTOR POSITION
- ΕΝΑΛΛΑΚΤΙΚΗ ΘΕΣΗ ΜΟΤΕΡ
- PROPOSED HANDLE POSITION



ORCHIDEA 150X150cm



Bathtub Dimensions: 150 x 150cm

Bathtub Net Weight: 34kg
Full Capacity: 250lt

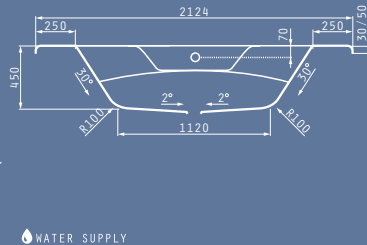
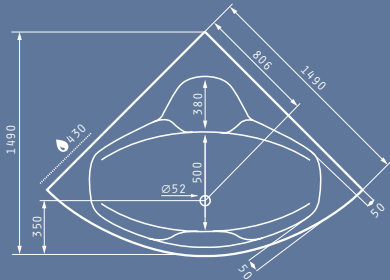

Description	Ar. Number
BATHTUB ORCHIDEA 150X150cm	022210201
BATHTUB ORCHIDEA 150X150cm WITH HYDROMASSAGE TURBO	183012401
BATHTUB ORCHIDEA 150X150cm WITH HYDROMASSAGE TURBO PLUS	183012501
BATHTUB ORCHIDEA 150X150cm WITH HYDRO & AIRMASSAGE TURBO	183113401
BATHTUB ORCHIDEA 150X150cm WITH HYDRO & AIRMASSAGE TURBO PLUS	183113501
PANEL ORCHIDEA 150X150cm	021105201

- PROPOSED MOTOR POSITION
- ALTERNATIVE MOTOR POSITION
- PROPOSED HANDLE POSITION



BATHTUB ACCESSORIES & INSTALLATION PARTS

Accessories	Ar. Number
BATH TUB HANDLE	021501601
BATHTUB AUTOMATIC WASTE VALVE	022009901
UNDERWATER LIGHTING	021502801
OZON THERAPY AND SANITATION SYSTEM	021502701
HYDROMASSAGE TOUCH CONTROL	021501901
HYDROMASSAGE & AIR MASSAGE TOUCH CONTROL	021502001
CHROMATOTHERAPY SYSTEM	021503301
ON-OFF CONTROL WITH WATER LEVEL SENSOR	021503601
Installation Parts	Ar. Number
BATHTUB INSTALLATION KIT	021501701
CORNER FEET SYSTEM	021501101
CORNER FEET SYSTEM FOR ORCHIDEA 140X140cm	021501501
ACCESS ALUMINUM COVER 45X35cm	021501801
HYDROMASSAGE 1Hp ECO Bathtub not included	021502201



anthemia series

BATHROOM

Anthemia series cover the needs for those who want to install a corner bathtub but they have limited available space.

This series consists of two models which can be placed either on a right or on a left corner. All models are available with hydro and/or air massage systems.

ANTHEMIA 153X99cm LEFT



Bathtub Dimensions: 153 x 99cm

Bathtub Net Weight: 24kg
Full Capacity: 310lt

Description	Ar. Number
BATHTUB ANTHEMIA 153x99cm R	022210902
BATHTUB ANTHEMIA 153x99cm L	022213002
BATHTUB ANTHEMIA 153x99cm R WITH HYDROMASSAGE TURBO	184030001
BATHTUB ANTHEMIA 153x99cm L WITH HYDROMASSAGE TURBO	184030201
BATHTUB ANTHEMIA 153x99cm R WITH HYDROMASSAGE TURBO PLUS	184030101
BATHTUB ANTHEMIA 153x99cm L WITH HYDROMASSAGE TURBO PLUS	184030301
BATHTUB ANTHEMIA 153x99cm R WITH HYDRO & AIRMASSAGE TURBO	184140101
BATHTUB ANTHEMIA 153x99cm L WITH HYDRO & AIRMASSAGE TURBO	184140401
BATHTUB ANTHEMIA 153x99cm R WITH HYDRO & AIRMASSAGE TURBO PLUS	184140201
BATHTUB ANTHEMIA 153x99cm L WITH HYDRO & AIRMASSAGE TURBO PLUS	184140301
PANEL ANTHEMIA 153x99cm REVERSIBLE	021600401

- PROPOSED MOTOR POSITION
- PROPOSED HANDLE POSITION

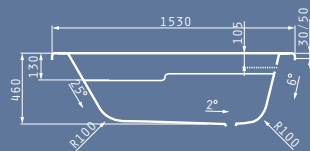
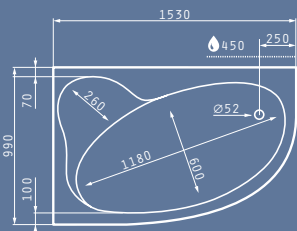

WATER SUPPLY

ANTHEMIA 160X90cm LEFT



Bathtub Dimensions: 160 x 90cm

Bathtub Net Weight: 21kg
Full Capacity: 250lt

Description	Ar. Number
BATHTUB ANTHEMIA 160x90cm R	022212202
BATHTUB ANTHEMIA 160x90cm L	022210002
BATHTUB ANTHEMIA 160x90cm R WITH HYDROMASSAGE TURBO	184030401
BATHTUB ANTHEMIA 160x90cm L WITH HYDROMASSAGE TURBO	184030601
BATHTUB ANTHEMIA 160x90cm R WITH HYDROMASSAGE TURBO PLUS	184030501
BATHTUB ANTHEMIA 160x90cm L WITH HYDROMASSAGE TURBO PLUS	184030701
BATHTUB ANTHEMIA 160x90cm R WITH HYDRO & AIRMASSAGE TURBO	184140501
BATHTUB ANTHEMIA 160x90cm L WITH HYDRO & AIRMASSAGE TURBO	184140701
BATHTUB ANTHEMIA 160x90cm R WITH HYDRO & AIRMASSAGE TURBO PLUS	184140601
BATHTUB ANTHEMIA 160x90cm L WITH HYDRO & AIRMASSAGE TURBO PLUS	184140801
PANEL ANTHEMIA 160x90cm REVERSIBLE	021201501

- PROPOSED MOTOR POSITION
- PROPOSED HANDLE POSITION

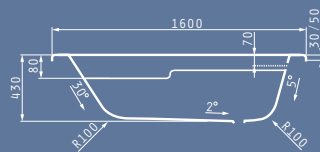
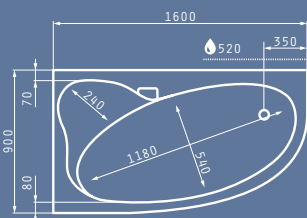

WATER SUPPLY

BATHTUB ACCESSORIES & INSTALLATION PARTS

Accessories	Ar. Number
BATH TUB HANDLE	021501601
BATHTUB AUTOMATIC WASTE VALVE	022009901
UNDERWATER LIGHTING	021502801
OZON THERAPY AND SANITATION SYSTEM	021502701
HYDROMASSAGE TOUCH CONTROL	021501901
HYDROMASSAGE & AIR MASSAGE TOUCH CONTROL	021502001
CHROMATOTHERAPY SYSTEM	021503301
ON-OFF CONTROL WITH WATER LEVEL SENSOR	021503601

Installation Parts	Ar. Number
BATHTUB INSTALLATION KIT	021501701
STANDARD FEET SYSTEM	021501001
FEET SYSTEM FOR VALERIA - ANTHEMIA WITH PANEL	021501301
ACCESS ALUMINUM COVER 45X35cm	021501801
HYDROMASSAGE 1Hp ECO Bathtub not included	021502201

- RIGHT: when the smaller side is on the right of the bathtub's facade
- LEFT: when the smaller side is on the left of the bathtub's facade



irida series

BATHROOM

Irida bathtubs feature minimalistic design. The series offers flexibility in space with three different in shape and design models.

All of them can be easily combined with hydromassage and airmassage systems to offer maximum pleasure in the bathroom.

IRIDA 170X75cm



Description	Ar. Number
BATHTUB IRIDA 170X75cm	022210701
BATHTUB IRIDA 170X75cm WITH HYDROMASSAGE TURBO	182040101
BATHTUB IRIDA 170X75cm WITH HYDROMASSAGE TURBO PLUS	182040201
BATHTUB IRIDA 170X75cm WITH HYDRO & AIRMASSAGE TURBO	182150101
BATHTUB IRIDA 170X75cm WITH HYDRO & AIRMASSAGE TURBO PLUS	182150201
PANEL IRIDA 170cm LONG	021600301
PANEL IRIDA 75cm WIDE	021400201

Bathtub Dimensions: 170 x 75cm

Bathtub Net Weight: 21kg
Full Capacity: 250lt

- PROPOSED MOTOR POSITION
- PROPOSED HANDLE POSITION

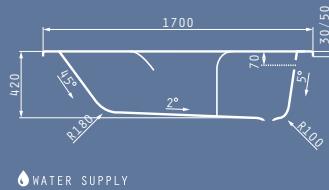
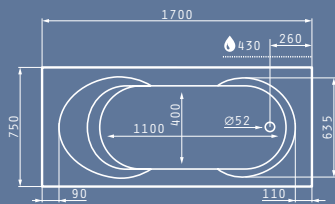
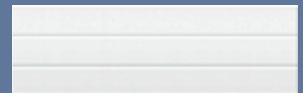

WATER SUPPLY

IRIDA 180X80cm



Description	Ar. Number
BATHTUB IRIDA 180X80cm	022213101
BATHTUB IRIDA 180X80cm WITH HYDROMASSAGE TURBO	182040301
BATHTUB IRIDA 180X80cm WITH HYDROMASSAGE TURBO PLUS	182040401
BATHTUB IRIDA 180X80cm WITH HYDRO & AIRMASSAGE TURBO	182150301
BATHTUB IRIDA 180X80cm WITH HYDRO & AIRMASSAGE TURBO PLUS	182150401
PANEL IRIDA 180cm LONG	021400301
PANEL IRIDA 80cm WIDE	021400401

Bathtub Dimensions: 180 x 80cm

Bathtub Net Weight: 28kg
Full Capacity: 330lt

- PROPOSED MOTOR POSITION
- ALTERNATIVE MOTOR POSITION
- PROPOSED HANDLE POSITION

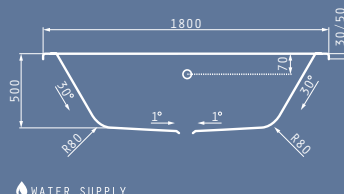
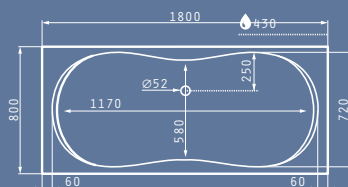
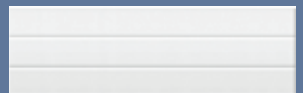

WATER SUPPLY

IRIDA 190X90cm



Description	Ar. Number
BATHTUB IRIDA 190X90cm	022210601
BATHTUB IRIDA 190X90cm WITH HYDROMASSAGE TURBO	182040501
BATHTUB IRIDA 190X90cm WITH HYDROMASSAGE TURBO PLUS	182040601
BATHTUB IRIDA 190X90cm WITH HYDRO & AIRMASSAGE TURBO	182150501
BATHTUB IRIDA 190X90cm WITH HYDRO & AIRMASSAGE TURBO PLUS	182150601
PANEL IRIDA 190cm LONG	021400501
PANEL IRIDA 90cm WIDE	021400601

Bathtub Dimensions: 190 x 90cm

Bathtub Net Weight: 31kg
Full Capacity: 400l

- PROPOSED MOTOR POSITION
- ALTERNATIVE MOTOR POSITION
- PROPOSED HANDLE POSITION

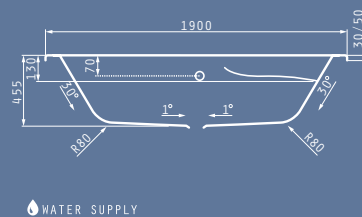
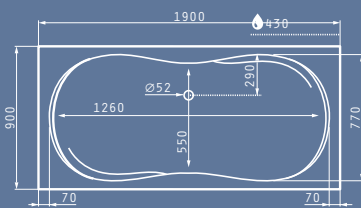
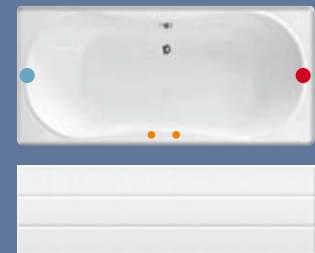

WATER SUPPLY

BATHTUB ACCESSORIES & INSTALLATION PARTS

Accessories	Ar. Number
BATH TUB HANDLE	021501601
BATHTUB AUTOMATIC WASTE VALVE	022009901
UNDERWATER LIGHTING	021502801
OZON THERAPY AND SANITATION SYSTEM	021502701
HYDROMASSAGE TOUCH CONTROL	021501901
HYDROMASSAGE & AIR MASSAGE TOUCH CONTROL	021502001
CHROMATOTHERAPY SYSTEM	021503301
ON-OFF CONTROL WITH WATER LEVEL SENSOR	021503601

Installation Parts	Ar. Number
BATHTUB INSTALLATION KIT	021501701
STANDARD FEET SYSTEM *	021501001
ACCESS ALUMINUM COVER 45X35cm	021501801
HYDROMASSAGE 1Hp ECO Bathtub not included	021502201



valeria series

BATHROOM

Valeria bathtubs offer the most cost effective choice in the bathroom. Without any compromise in quality and design, these eight models, of different dimensions, can fit in almost every bathroom.

The bathtubs of the range with a dimension above 150x70 are also available with hydromassage system Turbo or ECO.

VALERIA 120X70cm



Description	Ar. Number
BATHTUB VALERIA 120X70cm	022215001
PANEL VALERIA - ANEMONA 120cm LONG	021300101
PANEL VALERIA - ANEMONA 70cm WIDE	021300201

Bathtub Dimensions: 120 x 70cm

Bathtub Net Weight: 12kg
Full Capacity: 171lt

- PROPOSED MOTOR POSITION
- PROPOSED HANDLE POSITION

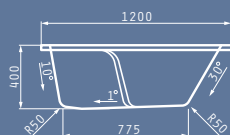
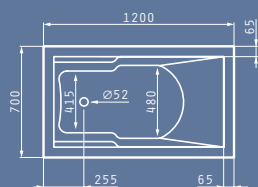
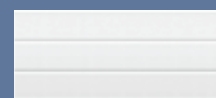
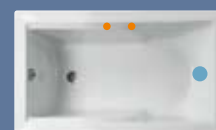

VALERIA 140X70cm



Description	Ar. Number
BATHTUB VALERIA 140X70cm	022215101
PANEL VALERIA 140cm LONG	021300301
PANEL VALERIA 70cm WIDE	021300201

Bathtub Dimensions: 140 x 70cm

Bathtub Net Weight: 15kg
Full Capacity: 177lt

- PROPOSED MOTOR POSITION
- PROPOSED HANDLE POSITION

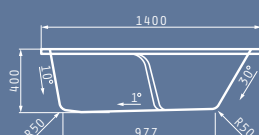
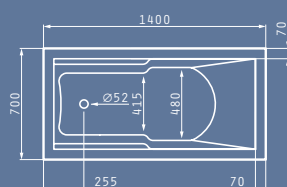
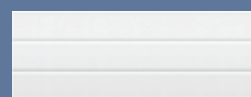
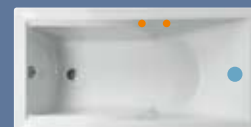

VALERIA 150X70cm



Description	Ar. Number
BATHTUB VALERIA 150X70cm	022215201
BATHTUB VALERIA 150X70cm WITH HYDROMASSAGE TURBO	185300001
PANEL VALERIA 150cm LONG	021300501
PANEL VALERIA 70cm WIDE	021300201

Bathtub Dimensions: 150 x 70cm

Bathtub Net Weight: 15kg
Full Capacity: 220lt

- PROPOSED MOTOR POSITION
- PROPOSED HANDLE POSITION

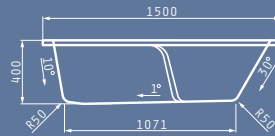
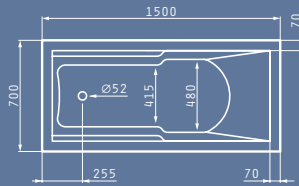
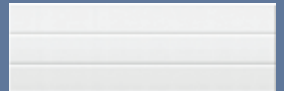

VALERIA 160X70cm



Description	Ar. Number
BATHTUB VALERIA 160X70cm	022215301
BATHTUB VALERIA 160X70cm WITH HYDROMASSAGE TURBO	185300101
PANEL VALERIA - ANEMONA 160cm LONG	021300701
PANEL VALERIA - ANEMONA 70cm WIDE	021300201

Bathtub Dimensions: 160 x 70cm

Bathtub Net Weight: 17kg
Full Capacity: 243lt

- PROPOSED MOTOR POSITION
- PROPOSED HANDLE POSITION

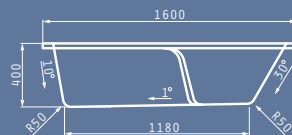
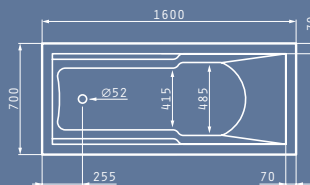
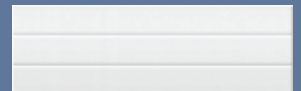

VALERIA 170X70cm



Description	Ar. Number
BATHTUB VALERIA 170X70cm	022215401
BATHTUB VALERIA 170X70cm WITH HYDROMASSAGE TURBO	185300201
PANEL VALERIA - ANEMONA 170cm LONG	021300901
PANEL VALERIA - ANEMONA 70cm WIDE	021300201

Bathtub Dimensions: 170 x 70cm

Bathtub Net Weight: 17kg
Full Capacity: 269lt

- PROPOSED MOTOR POSITION
- PROPOSED HANDLE POSITION

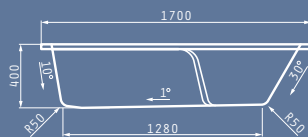
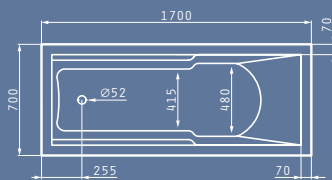
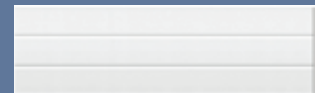
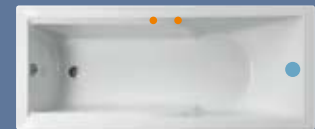

VALERIA 170X75cm



Description	Ar. Number
BATHTUB VALERIA 170X75cm	022215501
BATHTUB VALERIA 170X75cm WITH HYDROMASSAGE TURBO	185300301
PANEL VALERIA - ANEMONA 170cm LONG	021300901
PANEL VALERIA 75cm WIDE	021301201

Bathtub Dimensions: 170 x 75cm

Bathtub Net Weight: 21kg
Full Capacity: 275lt

- PROPOSED MOTOR POSITION
- PROPOSED HANDLE POSITION

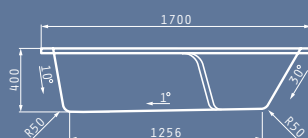
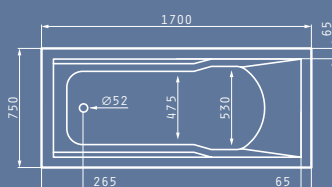
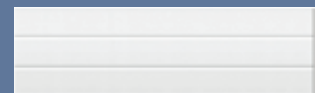
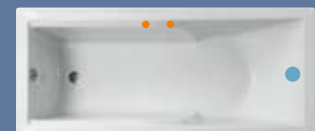

VALERIA 170X80cm



Description	Ar. Number
BATHTUB VALERIA 170X80cm	022215601
BATHTUB VALERIA 170X80cm WITH HYDROMASSAGE TURBO	185300401
PANEL VALERIA - ANEMONA 170cm LONG	021300901
PANEL VALERIA 80cm WIDE	021301401

Bathtub Dimensions: 170 x 80cm

Bathtub Net Weight: 22kg
Full Capacity: 270lt

- PROPOSED MOTOR POSITION
- PROPOSED HANDLE POSITION

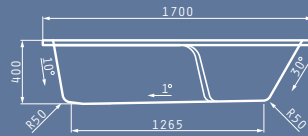
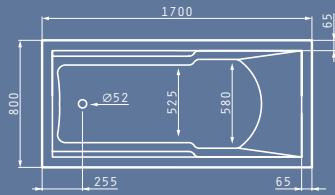
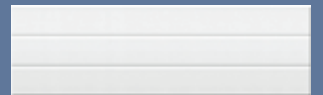
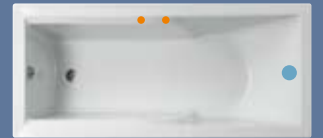

VALERIA 180X80cm



Description	Ar. Number
BATHTUB VALERIA 180X80cm	022215701
BATHTUB VALERIA 180X80cm WITH HYDROMASSAGE TURBO	185300501
PANEL VALERIA 180cm LONG	021301301
PANEL VALERIA 80cm WIDE	021301401

Bathtub Dimensions: 180 x 80cm

Bathtub Net Weight: 23kg
Full Capacity: 347lt

- PROPOSED MOTOR POSITION
- PROPOSED HANDLE POSITION

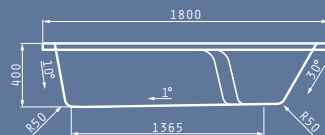
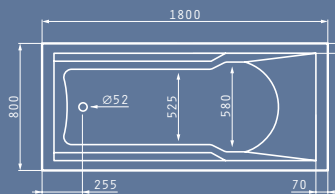
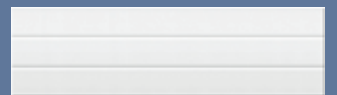
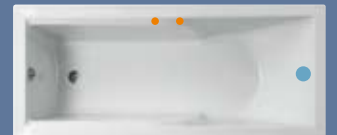

BATHTUB ACCESSORIES & INSTALLATION PARTS

Accessories	Ar. Number
BATH TUB HANDLE	021501601
BATHTUB AUTOMATIC WASTE VALVE	022009901
UNDERWATER LIGHTING	021502801
OZON THERAPHY AND SANITATION SYSTEM	021502701
HYDROMASSAGE TOUCH CONTROL	021501901
CHROMATOTHERAPY SYSTEM	021503301
ON-OFF CONTROL WITH WATER LEVEL SENSOR	021503601

Installation Parts	Ar. Number
BATHTUB INSTALLATION KIT	021501701
STANDARD FEET SYSTEM	021501001
FEET SYSTEM FOR VALERIA - ANTHEMIA WITH PANEL	021501301
ACCESS ALUMINUM COVER 45X35cm	021501801
HYDROMASSAGE 1Hp ECO Bathtub not included	021502201



anemona series

BATHROOM

Anemona bathtubs are the perfect solution for every contract project.

All three bathtubs, fulfill the demanded quality standards, while combining the contemporary design with right pricing.

ANEMONA 120X70cm



Description	Ar. Number
BATHTUB ANEMONA 120X70cm	022211002
PANEL VALERIA - ANEMONA 120cm LONG	021300101
PANEL VALERIA - ANEMONA 70cm WIDE	021300201

Bathtub Dimensions: 120 x 70cm

PROPOSED HANDLE POSITION

Bathtub Net Weight: 10kg
Full Capacity: 140lt

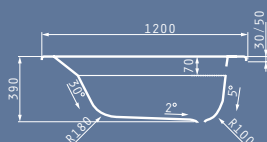
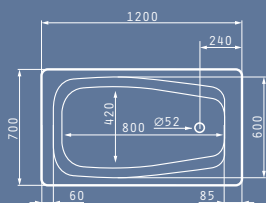
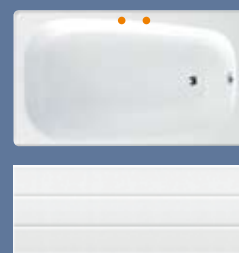

ANEMONA 160X70cm



Description	Ar. Number
BATHTUB ANEMONA 160X70cm	022211902
PANEL VALERIA - ANEMONA 160cm LONG	021300701
PANEL VALERIA - ANEMONA 70cm WIDE	021300201

Bathtub Dimensions: 160 x 70cm

PROPOSED HANDLE POSITION

Bathtub Net Weight: 12kg
Full Capacity: 220lt

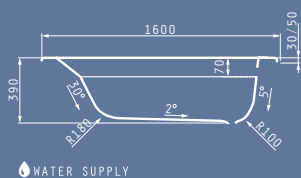
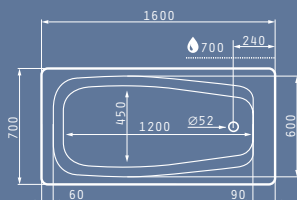

ANEMONA 170X70cm



Description	Ar. Number
BATHTUB ANEMONA 170X70cm	022211202
PANEL VALERIA - ANEMONA 170cm LONG	021300901
PANEL VALERIA - ANEMONA 70cm WIDE	021300201

Bathtub Dimensions: 170 x 70cm

Bathtub Net Weight: 12kg
Full Capacity: 240lt

● PROPOSED HANDLE POSITION

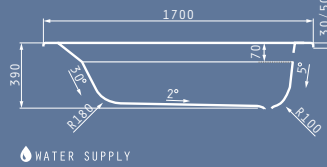
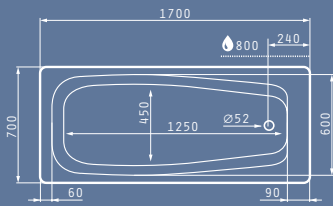
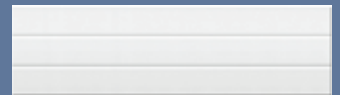
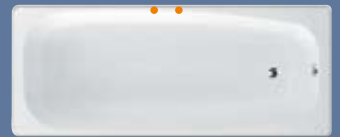

BATHTUB ACCESSORIES & INSTALLATION PARTS

Accessories	Ar. Number
BATH TUB HANDLE	021501601
BATHTUB AUTOMATIC WASTE VALVE	022009901

Installation Parts	Ar. Number
BATHTUB INSTALLATION KIT	021501701
STANDARD FEET SYSTEM	021501001
FEET SYSTEM FOR ANEMONA WITH PANEL	021501301
ACCESS ALUMINUM COVER 45X35cm	021501801



Sanitary Ware

PYRAMIS bathroom range includes five integrated lines of sanitary ware along with several individual pieces of WCs and washbasins. They are designed with respect to the contemporary needs of the everyday care offering the ideal solution for a stylish and functional bathroom. **PYRAMIS** porcelain sanitary ware is produced in a technologically advanced production unit

with specialized know-how and according to the highest standards. They are subjected to constant quality controls and they are certified by international organizations. This is the reason why the **PYRAMIS** sanitary ware is accompanied with **10 year guarantee** and 1 year for the auxiliary parts.

Advanced technical characteristics

PYRAMIS sanitary ware is manufactured with the most advanced methods. Therefore they ensure the highest quality and endurance standards.

- Water absorbancy < 0,5%
- Acid resistance
- Hot water resistance
- Stain resistance
- Abrasion and thermal shock resistance
- Bend resistance (M.O.P. = 500 kgr/cm²)
- Percussion resistance (1,3 kgr/cm²)





Back to Wall WCs

High aesthetic WCs with advanced design are placed with their back attached to the wall, covering completely the plumbing installation.



Universal WCs

All PYRAMIS models can be adjusted for P-trap or S-trap installation with a proper adaptor.



Wall hung WCs

They represent the ideal choice for domestic or professional use, saving a lot of space in the bathroom..



Soft close Seat & Covers

They have a specially designed mechanism for controlled closing and also they are supplied with metallic hinges for longer endurance.



Washbasins

Classic with normal or semi-pedestals, counter-top or under-counter, they fit in all bathrooms covering every need.



Mechanism 3/6 lt for cistern

Offers the choice of using the full tank water or the half tank water of the cistern.



DEKELIA

Dekelia includes a WC and a washbasin with exquisite square design that makes every bathroom unique. Their clean forms tone in the daily hygiene making it easier and more pleasant. Dekelia sanitary ware by Pyramis offers a high aesthetics proposal for bathrooms with style.



DEKELIA

*Dekelia includes a WC and a washbasin with exquisite square design that makes every bathroom unique. Their clean forms tone in the daily hygiene making it easier and more pleasant. Dekelia sanitary ware by **PYRAMIS** offers a high aesthetics proposal for bathrooms with style.*



ERETRIA

*Eretria represents an exclusive choice for those who seek the ultimate design and efficiency in their bathroom. The curvy lines, the contemporary aesthetics and the high quality of materials, offer the perfect combination for every day personal care. The Eretria line of sanitary ware by **PYRAMIS**, includes two WCs and two washbasins of different sizes and forms in order to cover the individual needs.*



10
years
guarantee



WASHBASIN ERETRIA 45x45

Description

WASHBASIN ERETRIA COUNTERTOP 450x450

Ar. Number

023000201

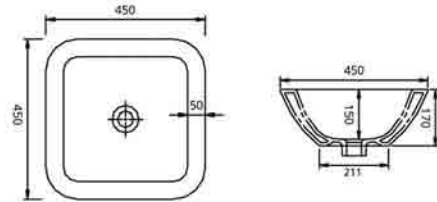

WASHBASIN ERETRIA 60x45

Description

WASHBASIN ERETRIA COUNTERTOP 600x450

Ar. Number

023000301

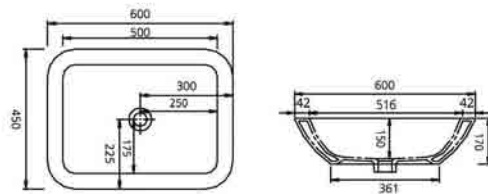

WC ERETRIA BTW LPP



Description	Ar. Number
WC ERETRIA BTW LPP 670x340	023000401
CISTERN ERETRIA MECHANISM 3/6LT PBI	023000501
SEAT & COVER ERETRIA SOFT CLOSE	023000601

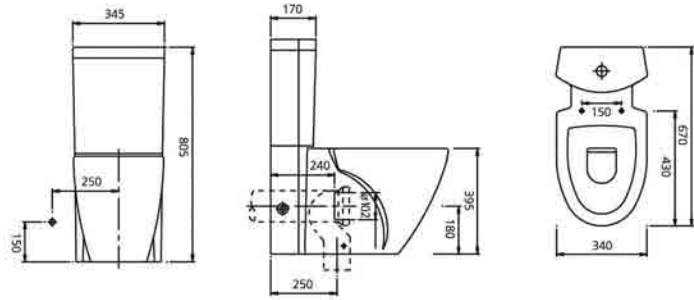

WC ERETRIA WALL HUNG



Description	Ar. Number
WC ERETRIA WALL HUNG 520x355	023000701
SEAT & COVER ERETRIA SOFT CLOSE	023000601

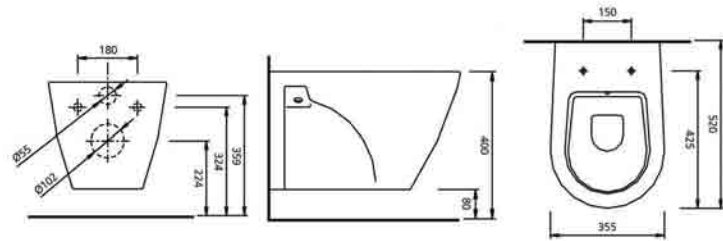

SPARE PARTS

Description	Ar. Number
MECHANISM FOR CISTERN 3/6LT PBI	023900001
CISTERN ERETRIA WITHOUT TOP COVER	023900101
TOP COVER FOR CISTERN ERETRIA	023900201

ETOLIA, LIDIA, ACTIUM

*Three unique pieces of superior design and aesthetics bring an alternative approach to your bathroom. The washbasins of **PYRAMIS** confirm the dynamic of style with their innovative forms and their sense of luxury. They cross the limits of a classic choice and offer the ideal proposal for a unique and modern bathroom.*

WASHBASIN ETOLIA

Description

WASHBASIN ETOLIA 800x500

Ar. Number

023003401



WASHBASIN LIDIA

Description

WASHBASIN LIDIA 500x500

Ar. Number

023003501

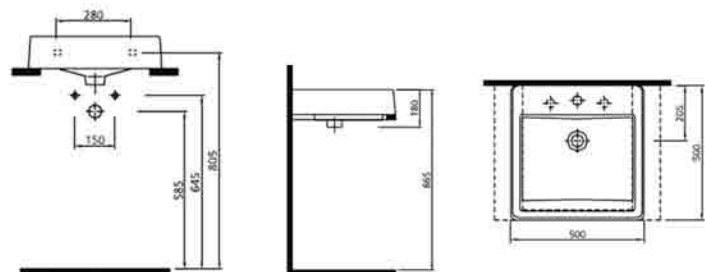

WASHBASIN ACTIUM

Description

WASHBASIN ACTIUM 800x410

Ar. Number

023003601

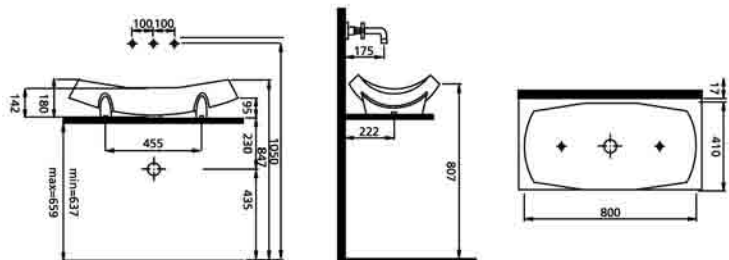

ELATIA

*Elatia is the intelligent proposal of **PYRAMIS** for sanitary ware. Soft curves and squared forms compose the ideal frame for a stylish and ergonomic bathroom. The small sizes of the WC and the 3 washbasins, offer a practical solution where space is not abundantly available, maximizing the potential and the benefits even of the smallest bathrooms.*



10
years
guarantee



WASHBASIN ELATIA BOWL

Description

WASHBASIN ELATIA BOWL COUNTERTOP 450

Ar. Number

023001201

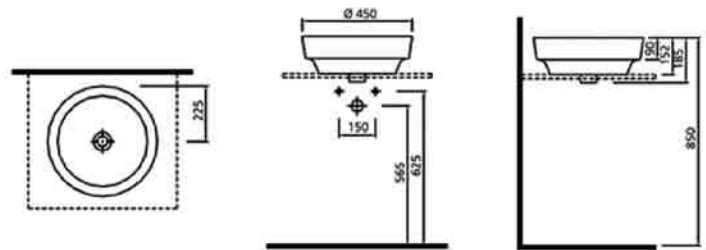

WASHBASIN ELATIA 450

Description

WASHBASIN ELATIA 450

Ar. Number

023001301

SEMI PEDESTAL ELATIA 450

023001401

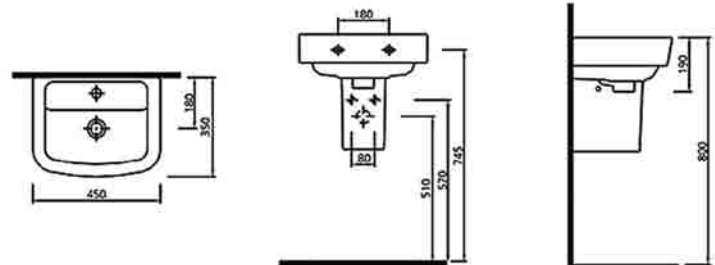

WASHBASIN ELATIA 600



Description	Ar. Number
WASHBASIN ELATIA 600	023001501
PEDESTAL ELATIA 600	023001601
SEMI PEDESTAL ELATIA 600	023001701

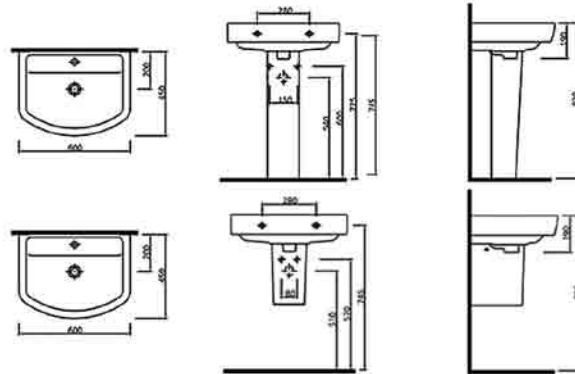

WC ELATIA



Description	Ar. Number
WC ELATIA 610x350	023001801
CISTERN ELATIA MECHANISM 3/6LT PBI	023001901
SEAT & COVER ELATIA	023002001
SEAT & COVER SOFT CLOSE	023005001

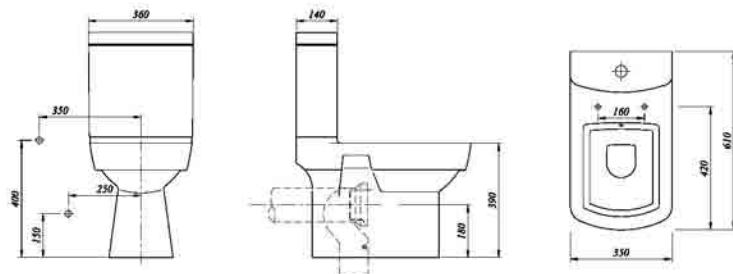

SPARE PARTS

Description	Ar. Number
MECHANISM FOR CISTERN 3/6LT PBI	023900001
CISTERN ELATIA WITHOUT TOP COVER	023900301
TOP COVER FOR CISTERN ELATIA	023900401

MILITOS

*Militos line of **PYRAMIS** sanitary ware is distinguished by its simplicity of style combined with its superior quality. It consists of a WC and a washbasin, both of which define harmony and minimal design in the bathroom.*



WASHBASIN MILITOS



Description	Ar. Number
WASHBASIN MILITOS 600	023002101
PEDESTAL MILITOS 600	023002201

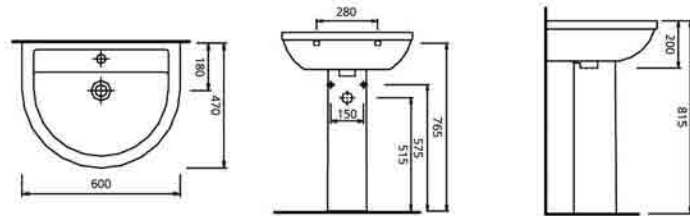

WC MILITOS



Description	Ar. Number
WC MILITOS LPP 690X350	023002301
CISTERN MILITOS MECHANISM START-STOP 3/8 BI	023002401
SEAT & COVER MILITOS	023002501
SEAT & COVER MILITOS SOFT CLOSE	023005101

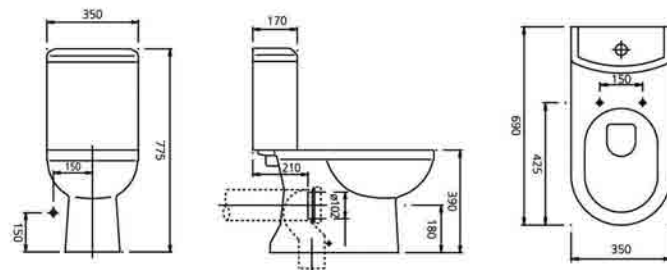

SPARE PARTS

Description	Ar. Number
MECHANISM FOR CISTERN START-STOP 3/8 BI	023900501
CISTERN MILITOS WITHOUT TOP COVER	023900601
TOP COVER FOR CISTERN MILITOS	023900701



TROY

*Troy is the most cost effective choice of **PYRAMIS** sanitary ware. It is a complete line, consisting of one WC and one wash-basin that covers the needs of everyday personal care to the maximum, at the minimum cost. Therefore Troy represents the ideal solution for project bathrooms and country houses.*

WASHBASIN TROY



Description	Ar. Number
WASHBASIN TROY 560	023002601
PEDESTAL TROY 560	023002701

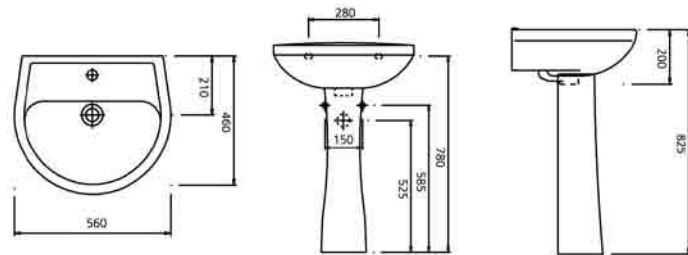

WC TROY



Description	Ar. Number
WC TROY LPP 665x350	023002801
CISTERN TROY SQ MECHANISM NP BI	023002902
SEAT & COVER TROY	023003001

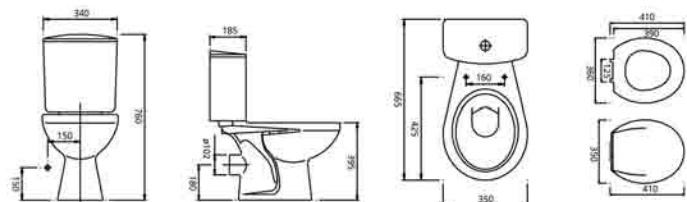

SPARE PARTS

Description	Ar. Number
MECHANISM FOR CISTERN TROY NP SI	023900801
CISTERN SQ TROY WITHOUT TOP COVER	023900902
TOP COVER FOR CISTERN TROY SQ	023901002

WASHBASINS

***PYRAMIS** under-counter and inset washbasins play with the lines and the perspective of the bathroom, re-defining the ultimate design. Three different choices, in different dimensions, combine harmonically, high aesthetics with everyday hygiene.*

WASHBASIN UNDERCOUNTER 530

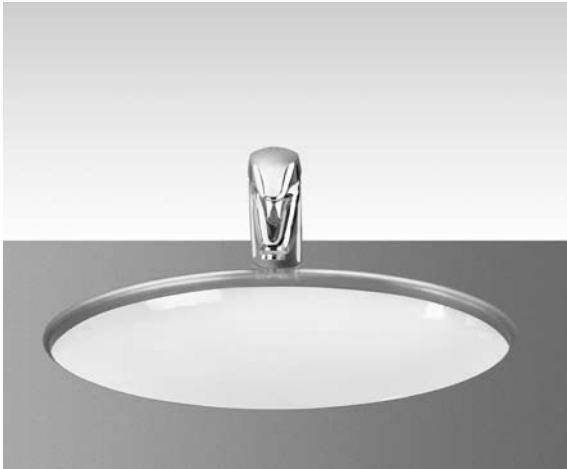

Description	Ar. Number
WASHBASIN UNDERCOUNTER 530	023003701

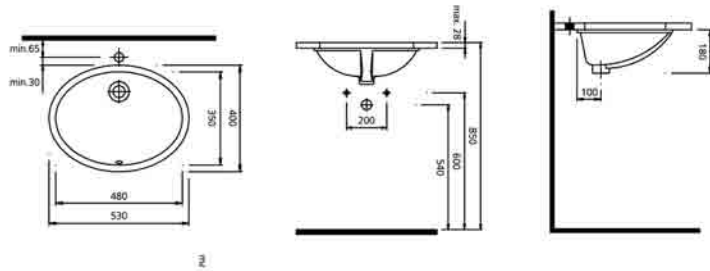

WASHBASIN UNDERCOUNTER 580



Description	Ar. Number
WASHBASIN UNDERCOUNTER 580	023003801

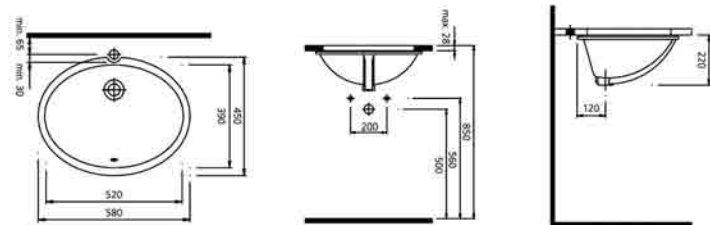

WASHBASIN COUNTERTOP 600



Description	Ar. Number
WASHBASIN COUNTERTOP 600	023003901

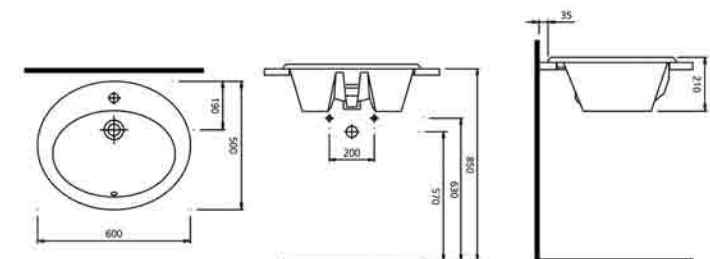

WCs & URINAL

PYRAMIS proposal for construction projects, includes one high pressure WC, one wall-hung WC and a urinal. Three different solutions for projects, that don't compromise at all in quality but only in price.



WC HIGH PRESSURE



Description	Ar. Number
WC HIGH PRESSURE P 460x350	023003101
SEAT & COVER TROY	023003001

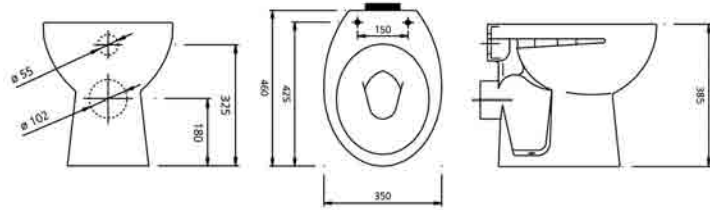

WC WALL HUNG



Description	Ar. Number
WC WALL HUNG 515x350	023003201
SEAT & COVER WALL HUNG	023004001

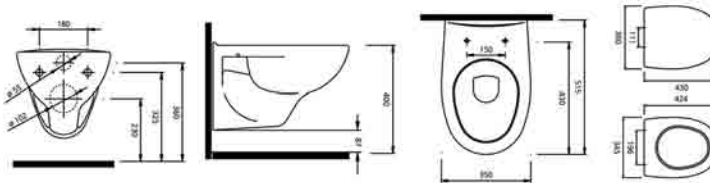

URINAL



Description	Ar. Number
URINAL CONSEALED OUTLET BI 550x360	023003301

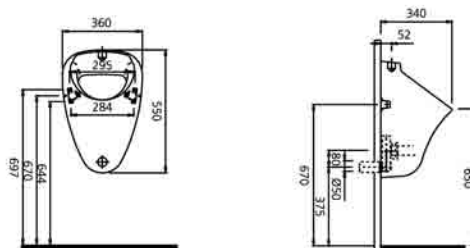

BATHROOM TAPS

The new distinctive range of **PYRAMIS** bathroom taps features exceptional design attributes and each model is made using the highest quality production standards. Available in classic or modern styles to suit all preferences, each tap can be perfectly combined with **PYRAMIS** stainless steel or porcelain washbasins or bathtubs. All **PYRAMIS** taps are covered by a five year guarantee.



Pop Up Valve

All basin models have a pop up valve that seals and opens the outflow with one effortless movement.

Level Water Flow

In selected models, there are two predetermined water flows (high-low) that ensure the optimum efficiency of water quantity and temperature.

Features and Properties

All PYRAMIS bathroom taps are manufactured according to ISO 9001:2000.

Dynamic Pressure Conditions

All taps are suitable for dynamic water pressure min= 0.5 bar to max= 5.0 bar.

STRETO

BATHROOM

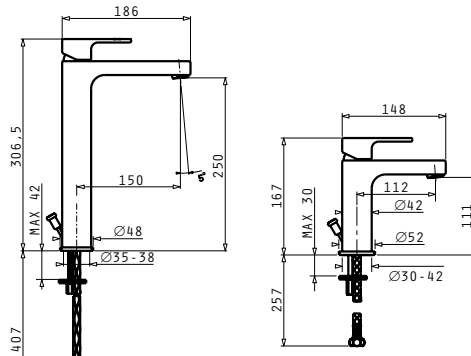

Description	Ar. Number
WASH BASIN TAP XL	098110501
SHOWER BATH TAP	098010101

Single lever washbasin mixers with pop - up valve

Description	Ar. Number
SHOWER RAIL STRETO	098110601

Rectangular shower rail with antilimestone shower head and hand-shower

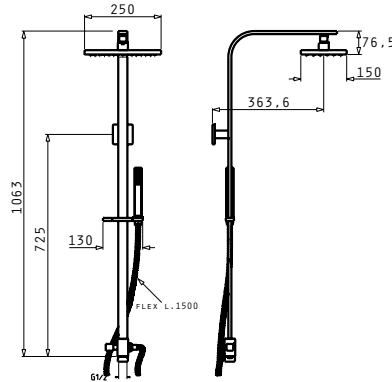

Description	Ar. Number
SHOWER BATH TAP	098010201

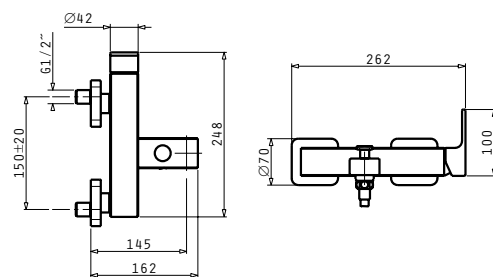

External single lever shower bath mixer with automatic diverter and shower with wall stand

Description	Ar. Number
SHOWER BATH TAP	098110701

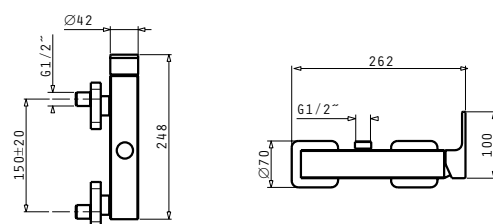

External Shower mixer without shower kit- high exit water for connection to shower rail

ELEGATO

BATHROOM

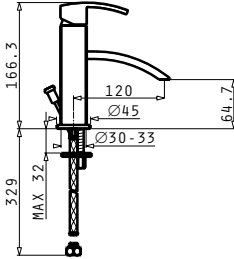

Description	Ar. Number
WASH BASIN TAP	098000101
SHOWER BATH TAP	098000201

Single lever wash basin mixer with pop - up valve

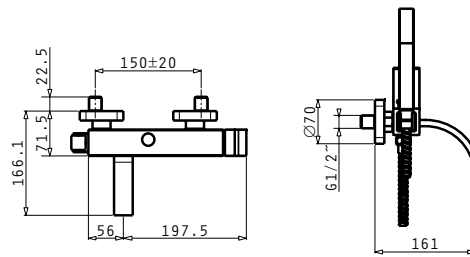

External single lever shower bath mixer with automatic diverter and shower with wall stand

MATINATA

BATHROOM

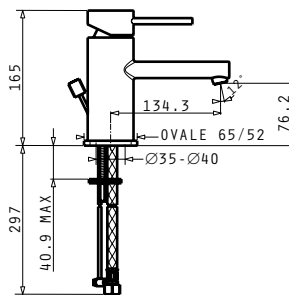

Description	Ar. Number
WASH BASIN TAP ROTA CHROME	098020101
SHOWER BATH TAP ROTA CHROME	098020201

Single lever wash basin mixer with pop-up valve

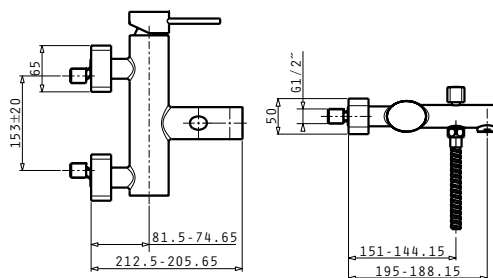

External single lever shower bath mixer with automatic diverter and shower with wall stand

VISCARIA

BATHROOM

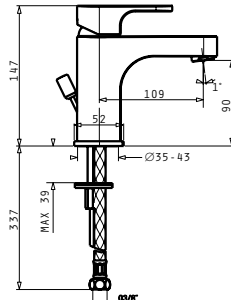

Description	Ar. Number
WASH BASIN TAP VISCARIA	098110801

Single lever wash basin mixer with pop-up valve

Description	Ar. Number
SHOWER RAIL VISCARIA	098111001

Rectangular shower rail with antilimestone shower head and hand-shower

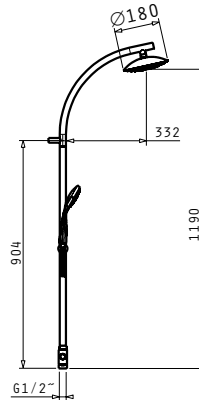

Description	Ar. Number
SHOWER BATH TAP VISCARIA	098110901

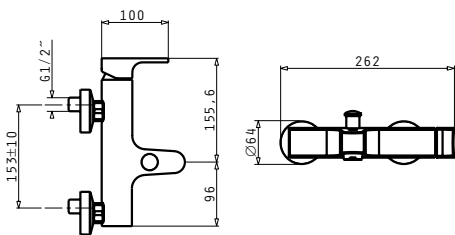

External single lever shower bath mixer with automatic diverter and shower with wall stand

Description	Ar. Number
SHOWER BATH TAP VISCARIA NO SHOWER KIT-HIGH EXIT WATER	098111101

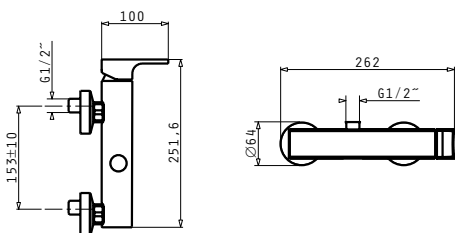

External Shower mixer without shower kit- high exit water for connection to shower rail

ROTA

BATHROOM

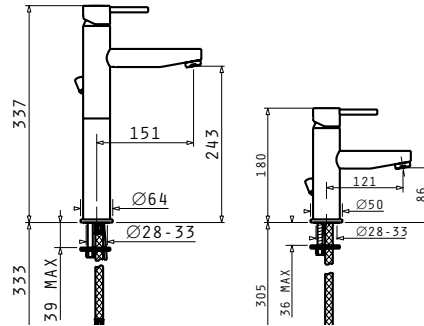

Description	Ar. Number
WASH BASIN TAP ROTA	098030101
WASH BASIN TAP ROTA XL	098030301
SHOWER BASIN TAP ROTA	098030201

Single lever wash basin mixers with pop-up valve

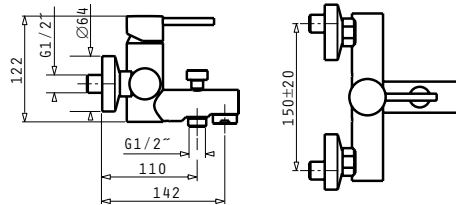

External single lever shower bath mixer with automatic diverter and shower with wall stand

RUSTICO

BATHROOM

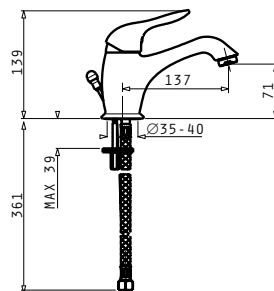

Description	Ar. Number
WASH BASIN TAP RUSTICO	098050101
SHOWER BATH TAP RUSTICO	098050201

Single lever wash basin mixer with pop-up valve

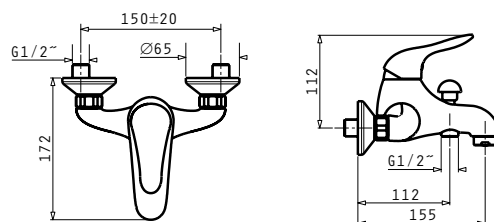

External single lever shower bath mixer with automatic diverter and shower with wall stand

CANTANDO

BATHROOM

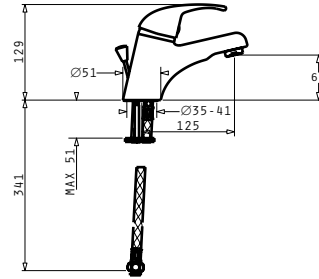

Description Ar. Number

WASH BASIN TAP CANTANDO 098070101

SHOWER BATH TAP CANTANDO 098070201

Single lever wash basin mixer with pop-up valve

External single lever shower bath mixer with automatic diverter and shower with wall stand

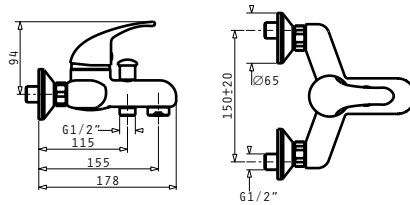

SOLFFEGIO

BATHROOM

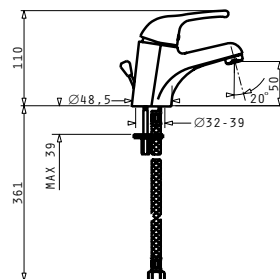

Description Ar. Number

WASH BASIN TAP SOLFFEGIO 098110101

SHOWER BATH TAP SOLFFEGIO 098110201

Single lever wash basin mixer with pop-up valve

External single lever shower bath mixer with automatic diverter and shower with wall stand

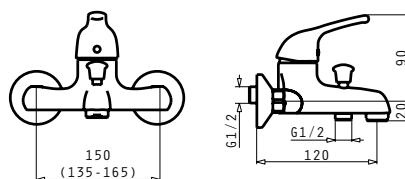



STAINLESS STEEL WASHBASINS

Bolero and Ravel washbasins add impact and style to any type of bathroom furniture whether it is wood, marble, granite or glass. This pair of perfectly polished washbasins will be the spotlight of any bathroom.

25
years
guarantee

● STAINLESS STEEL WASHBASINS

BOLERO

Finish	Ar. Number	Tap Holes	Waste	Packaging
POLISHED	100077101	1 Tap Hole	Ø52mm	1 Item/Carton Box



Sink Dimensions: Ø450mm
 Bowl Dimensions: Ø385 x 160mm
 Minimum Base Unit: **45cm**
 Bowl Overflow

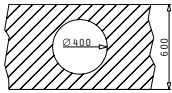
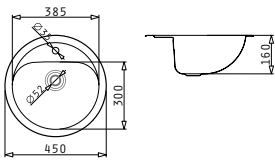

Cutout template supplied in packaging

Suitable Waste Fittings



Inset Profile 5



RAVEL

Finish	Ar. Number	Waste	Packaging
POLISHED	100077001	Ø52mm	1 Item/Carton Box



Sink Dimensions: Ø450mm
 Bowl Dimensions: Ø385 x 160mm
 Minimum Base Unit: **45cm**
 Bowl Overflow

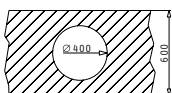
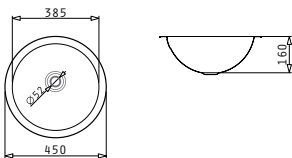

Cutout template supplied in packaging

Suitable Waste Fittings



Inset Profile 5



NASHIRA

*Stainless steel (CrNi 18/10) choices, **satin** finished, that serve the daily needs in the bathroom with ergonomic style. Mirrors, towel holders, shower buttlers, toilet brushes, toilet roll holders and glass shelves... feature uncompromised, cost-effective quality in the bathroom, by **PYRAMIS**.*





NASHIRA HOOK SET 2PCS

Dimensions

2 x 3 x 2,3cm

Ar. Number

023801201



NASHIRA TOWEL HOLDER 60

Dimensions

Ø1,6 x 2,4cm

Ar. Number

023801301



NASHIRA TOWEL HOLDER 60 DOUBLE

Dimensions

14 x 60cm

Ar. Number

023801401



NASHIRA TOWEL SHELF

Dimensions

26 x 60cm

Ar. Number

023801501



NASHIRA TOILET ROLL HOLDER

Dimensions

8 x 18cm

Ar. Number

023801601



NASHIRA SPARE TOILET ROLL HOLDER

Dimensions

14 x 25,5 x 9cm

Ar. Number

023801701



NASHIRA SHELF GLASS PLATE

Dimensions

12 x 60cm

Ar. Number

023801801



NASHIRA TOOTHBRUSH HOLDER

Dimensions

9 x 12 x 6cm

Ar. Number

023801901



NASHIRA SOAP DISPENSER

Dimensions

14 x 18,5 x 6cm

Ar. Number

023802001



NASHIRA WALL MOUNTED TOILET BRUSH

Dimensions

12 x 39 x 9cm

Ar. Number

023802101



NASHIRA TOILET BRUSH

Dimensions

∅9 x 39cm

Ar. Number

023802201



NASHIRA SHOWER BUTTLER 30

Dimensions

12 x 30 x 7,5cm

Ar. Number

023802301



NASHIRA SHOWER BUTTLER 45

Dimensions

12 x 45 x 7,5cm

Ar. Number

023802401



NASHIRA SHOWER TOWEL HOLDER 30

Dimensions

12 x 30 x 2cm

Ar. Number

023802501



NASHIRA WALL MIRROR

Dimensions

60 x 60cm

Ar. Number

023802601

ZAFIRA

*Stainless steel (CrNi 18/10) bathroom accessories, **mirror polished**, that add to the aesthetics of the bathroom. They offer smart solutions to daily hygiene transforming it into pleasure. Towel holders, shower buttlers, toilet brushes, shelves and other items of timeless value and impeccable design, by **PYRAMIS**.*





ZAFIRA HOOK SET 2PCS

Dimensions

∅1,6 x 2,4cm

Ar. Number

023800001



ZAFIRA TOWEL HOLDER 60

Dimensions

8 x 60cm

Ar. Number

023800101



ZAFIRA TOWEL HOLDER 60 DOUBLE

Dimensions

14 x 60cm

Ar. Number

023800201



ZAFIRA TOWEL SHELF

Dimensions

26 x 60cm

Ar. Number

023800301



ZAFIRA TOILET ROLL HOLDER

Dimensions

10 x 18,4cm

Ar. Number

023800401



ZAFIRA SPARE TOILET ROLL HOLDER

Dimensions

13 x 26 x 9cm

Ar. Number

023800501



ZAFIRA SHELF GLASS PLATE

Dimensions

14 x 60cm

Ar. Number

023800601



ZAFIRA SOAP DISH HOLDER

Dimensions

13,4 x 10cm

Ar. Number

023800701



ZAFIRA TOOTHBRUSH HOLDER

Dimensions

9 x 12 x 6cm

Ar. Number

023800801



ZAFIRA SOAP DISPENSER

Dimensions

9 x 12 x 6cm

Ar. Number

023800901



ZAFIRA WALL MOUNTED TOILET BRUSH

Dimensions

9 x 12 x 6cm

Ar. Number

023801001



ZAFIRA TOILET BRUSH

Dimensions

∅9 x 39cm

Ar. Number

023801101

SOLAR SYSTEMS

***PYRAMIS** solar water heaters combine the most advanced collectors -simple or selective- with the latest developed boiler-tank, maximizing the performance even of the weakest sunshine.*



*The **PYRAMIS** boiler-tank is designed according to the highest quality standards and ensures the maximum effectiveness and performance.*

*The absorber: is a **one piece** copper sheet with: **a.** Simple black coating achieving **65%** sun absorbency **b.** Blue colored (any other color is not 100% selective) **Blue Tech** selective coating achieving **95%** sun absorbency. This coating ensures 16% higher energy performance during winter and fall which leads to 10% more yearly average energy performance than the simple collectors.*

Water Tank

1. Water tank made of steel foil (DCP) 2,5mm thick. It has ONE horizontal welding instead of three which is most often the case by competition. The welding endurance is tested under a pressure of 15 bars. The inner protection of the tank is done with smalt-coating of double vitrification, in 860oC.
2. Insulation with cast ecological polyurethane, with 40kg/m² density and 60mm thickness. It covers uniformly the tank, ensuring the preservations of the water temperature, for longer time.
3. External casing from non ferrous stainless steel material (304) 0,5mm thick, for longer time and weather endurance.
4. Closed circuit double jacket made of steel foil 1,5mm that helps the circulation of the thermal liquid achieving the best heat convection..
5. Inner dilation receptacle on the upper side of the jacket which prevents the detonation of the thermal liquid and therefore its deficiency.
6. Electrical resistance 4KW with bipolar safety thermostat.
7. Magnesium rod, Ø22mm and length 350mm, that can be replaced, for protections against electrolysis.
8. Vent for filling the closed circuit with safety valve of 2 bars.
9. Water supply safety valve (10 bars).
10. Different options of triple energy tanks with large surface durosalt heat commutator (G3/4") to be connected with the central heating system.

Collector

1. **The absorbers tubes:** are copper pipes of Ø10 & Ø22 that are welded to the absorber sheet by the advanced method of ultrasounds "Ultrasonic". This method, compared to the laser welding, is proven to be the most effective one as it ensures safe and long lasting welding for a life-time.
2. **The insulation:** is with rock wool of low conductance 40mm thick, covered with black fibreglass for better thermal efficiency.
3. **The glass-panel:** is unbreakable (Mistlite Tempered-Security Low Iron Glass), 4mm thick, with low iron conciseness for better sun penetrability τ=92%. It is totally transparent so that the high quality of the inner solar system can be easily visible.
4. **The back:** is a mixture of galvanized sheet and aluminum 0,5mm thick.
5. **The outer frame:** is a thermal break profile aluminum for better heat insulation and time resistance of the collector.
6. **The thermal liquid:** is a special antifreeze liquid (propyle glykol) that shields the system from the environmental freezing or overheating temperatures, calc and oxidation preserving the excellent performance of the solar system.
7. **The base:** specially hot galvanized installation basis for flat surfaces or tile roofs, all kind of weather resistant.

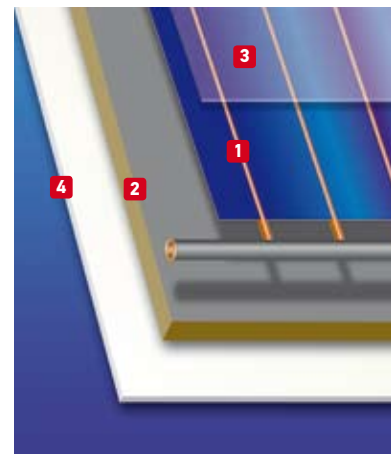
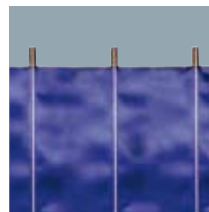
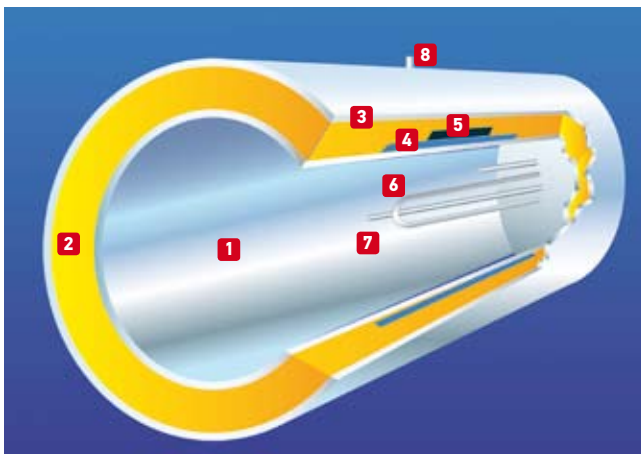



SOLAR WATERHEATER 120t SIMPLE COLLECTOR PANEL

Description	Type	Collector's Surface	Collectors	Ar. Number
Solar Waterheater 120t Simple Collector Panel	Normal	2m ²	1	026000701
Solar Waterheater 120t Simple Collector Panel	Triple Energy	2m ²	1	026001501



SOLAR WATERHEATER 160t SIMPLE COLLECTOR PANEL

Description	Type	Collector's Surface	Collectors	Ar. Number
Solar Waterheater 160t Simple Collector Panel	Normal	1,5m ²	2	026000801
Solar Waterheater 160t Simple Collector Panel	Triple Energy	1,5m ²	2	026001601



SOLAR WATERHEATER 200t SIMPLE COLLECTOR PANEL

Description	Type	Collector's Surface	Collectors	Ar. Number
Solar Waterheater 200t Simple Collector Panel	Normal	2m ²	2	026000901
Solar Waterheater 200t Simple Collector Panel	Triple Energy	2m ²	2	026001701



SOLAR WATERHEATER 120lt SELECTIVE COLLECTOR PANEL

Description	Type	Collector's Surface	Collectors	Ar. Number
Solar Waterheater 120lt Selective Collector Panel	Normal	2m ²	1	026000201
Solar Waterheater 120lt Selective Collector Panel	Triple Energy	2m ²	1	026001001



SOLAR WATERHEATER 160lt SELECTIVE COLLECTOR PANEL

Description	Type	Collector's Surface	Collectors	Ar. Number
Solar Waterheater 160lt Selective Collector Panel	Normal	2m ²	1	026000301
Solar Waterheater 160lt Selective Collector Panel	Triple Energy	2m ²	1	026001101



SOLAR WATERHEATER 160lt SELECTIVE COLLECTOR PANEL

Description	Type	Collector's Surface	Collectors	Ar. Number
Solar Waterheater 160lt Selective Collector Panel	Normal	1,5m ²	2	026000401
Solar Waterheater 160lt Selective Collector Panel	Triple Energy	1,5m ²	2	026001201



SOLAR WATERHEATER 200lt SELECTIVE COLLECTOR PANEL

Description	Type	Collector's Surface	Collectors	Ar. Number
Solar Waterheater 200lt Selective Collector Panel	Normal	1,5m ²	2	026000501
Solar Waterheater 200lt Selective Collector Panel	Triple Energy	1,5m ²	2	026001301



SOLAR WATERHEATER 200lt SELECTIVE COLLECTOR PANEL

Description	Type	Collector's Surface	Collectors	Ar. Number
Solar Waterheater 200lt Selective Collector Panel	Normal	2m ²	2	026000601
Solar Waterheater 200lt Selective Collector Panel	Triple Energy	2m ²	2	026001401

WATERHEATERS BOILERS

PYRAMIS water heaters and boilers are produced with the latest technological advancements, under the strictest safety standards. They offer a cost effective choice with maximum performance so that you can enjoy, problem free, hot water in the bathroom and the kitchen.

PRODUCT DESCRIPTION

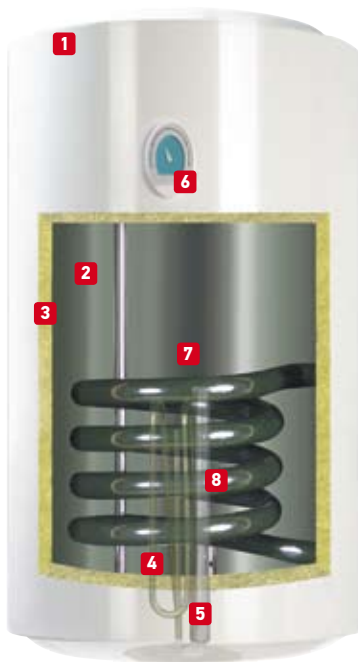

1. External Casing from steel foil **0,7mm** thick, electrostatic painted at **200°C** (except for the 10lt water heater).

2. Boiler made of steel foil 2,5mm thick, especially deep drawn, which endurance is tested at 15 bars. The water tank has one horizontal welding which offers:

- Great resistance in corrosion
- Great mechanical endurance
- Unlimited life time
- Less weldings ensure better and more unified vitrification

3. Good insulation with **ecological polyurethane 40 kg/m³** dense and **25mm** thick, that preserves the hot temperature for a longer time.

4. Electric Resistance 4kw with safety thermostat, easy to replace.

5. Magnesium Rod for total protection against electrolysis.

6. Thermometer

7. Double Vitrification

Internal protection of the boiler with double enameled coating. The smalt is applied on the metal surface and by heat at **860°C** where a conjunctional coating of smalt and metal is created. Thus, the concrete structure and elasticity of the metal is combined with the hardness and the chemical resistance of the glass. As a result, the boiler is totally protected from rust as the water never contacts the metal surface and remains always clean. Also it includes a safety valve of **10Bar**.

8. Double energy water heaters – boilers (except for the 10lt heater) they function with a smalted spiral inverter which ensures faster heat transmission and higher protection against corrosion..

Quality control occurs on every product separately and not randomly

DESCRIPTION	POWER	MAX PRESSURE	TESTING PRESSURE	DIMENSIONS	TYPE	AR.NUMBER
WATERHEATER 10 lt	1500W	10bar	12bar	26,5x39x23,5cm	VERTICAL	027001101
WATERHEATER 10 lt	1500W	10bar	12bar	26,5x39x23,5cm	FLOOR	027011101
WATERHEATER 25 lt	2500W	10bar	12bar	∅40cm / 43cm	VERTICAL	027002501
WATERHEATER 40 lt	4000W	10bar	12bar	∅40cm / 53cm	VERTICAL	027004001
WATERHEATER 40 lt	4000W	10bar	12bar	∅40cm / 53cm	FLOOR	027014001
WATERHEATER 40 lt RIGHT	4000W	10bar	12bar	∅40cm / 53cm	HORIZONTAL	027024001
WATERHEATER 40 lt LEFT	4000W	10bar	12bar	∅40cm / 53cm	HORIZONTAL	027024002
WATERHEATER 60 lt	4000W	10bar	12bar	∅45cm / 62cm	VERTICAL	027006001
WATERHEATER 60 lt	4000W	10bar	12bar	∅45cm / 62cm	FLOOR	027016001
WATERHEATER 60 lt RIGHT	4000W	10bar	12bar	∅45cm / 62cm	HORIZONTAL	027026001
WATERHEATER 60 lt LEFT	4000W	10bar	12bar	∅45cm / 62cm	HORIZONTAL	027026002
WATERHEATER 80 lt	4000W	10bar	12bar	∅45cm / 77cm	VERTICAL	027008001
WATERHEATER 80 lt	4000W	10bar	12bar	∅45cm / 77cm	FLOOR	027018001
WATERHEATER 80 lt RIGHT	4000W	10bar	12bar	∅45cm / 77cm	HORIZONTAL	027028001
WATERHEATER 80 lt LEFT	4000W	10bar	12bar	∅45cm / 77cm	HORIZONTAL	027028002
WATERHEATER 100 lt	4000W	10bar	12bar	∅45cm / 93cm	VERTICAL	027001001
WATERHEATER 100 lt	4000W	10bar	12bar	∅45cm / 93cm	FLOOR	027011001
WATERHEATER 100 lt RIGHT	4000W	10bar	12bar	∅45cm / 93cm	HORIZONTAL	027021001
WATERHEATER 100 lt LEFT	4000W	10bar	12bar	∅45cm / 93cm	HORIZONTAL	027021002

WATERHEATER - BOILER 60 lt RIGHT	4000W	10bar	12bar	∅45cm / 62cm	VERTICAL	028006001
WATERHEATER - BOILER 60 lt LEFT	4000W	10bar	12bar	∅45cm / 62cm	VERTICAL	028006002
WATERHEATER - BOILER 60 lt	4000W	10bar	12bar	∅45cm / 62cm	FLOOR	028016001
WATERHEATER - BOILER 60 lt RIGHT	4000W	10bar	12bar	∅45cm / 62cm	HORIZONTAL	028026001
WATERHEATER - BOILER 60 lt LEFT	4000W	10bar	12bar	∅45cm / 62cm	HORIZONTAL	028026002
WATERHEATER - BOILER 80 lt RIGHT	4000W	10bar	12bar	∅45cm / 77cm	VERTICAL	028008001
WATERHEATER - BOILER 80 lt LEFT	4000W	10bar	12bar	∅45cm / 77cm	VERTICAL	028008002
WATERHEATER - BOILER 80 lt	4000W	10bar	12bar	∅45cm / 77cm	FLOOR	028018001
WATERHEATER - BOILER 80 lt RIGHT	4000W	10bar	12bar	∅45cm / 77cm	HORIZONTAL	028028001
WATERHEATER - BOILER 80 lt LEFT	4000W	10bar	12bar	∅45cm / 77cm	HORIZONTAL	028028002
WATERHEATER - BOILER 100 lt RIGHT	4000W	10bar	12bar	∅45cm / 93cm	VERTICAL	028001001
WATERHEATER - BOILER 100 lt LEFT	4000W	10bar	12bar	∅45cm / 93cm	VERTICAL	028001002
WATERHEATER - BOILER 100 lt	4000W	10bar	12bar	∅45cm / 93cm	FLOOR	028011001
WATERHEATER - BOILER 100 lt RIGHT	4000W	10bar	12bar	∅45cm / 93cm	HORIZONTAL	028021001
WATERHEATER - BOILER 100 lt LEFT	4000W	10bar	12bar	∅45cm / 93cm	HORIZONTAL	028021002
WATERHEATER - BOILER 120 lt RIGHT	4000W	10bar	12bar	∅45cm / 108cm	VERTICAL	028001201
WATERHEATER - BOILER 120 lt LEFT	4000W	10bar	12bar	∅45cm / 108cm	VERTICAL	028001202
WATERHEATER - BOILER 120 lt	4000W	10bar	12bar	∅45cm / 108cm	FLOOR	028011201
WATERHEATER - BOILER 120 lt RIGHT	4000W	10bar	12bar	∅45cm / 108cm	HORIZONTAL	028021201
WATERHEATER - BOILER 120 lt LEFT	4000W	10bar	12bar	∅45cm / 108cm	HORIZONTAL	028021202



WATERHEATER 10 lt



WATERHEATER 40 lt



WATERHEATER 60 lt



WATERHEATER 80 lt

BATHTUBS	ITEMS PER PALLET	PALLET DIMENSIONS	PALLETS PER 20"/40" CONTAINER	PALLETS PER TRUCK
BATHTUBS ELEGANCIA				
BATHTUB ELAGANCIA 170X70cm	20	175X75	9/19	22
BATHTUB ELAGANCIA 170X80cm	20	175X85	6/13	16
BATHTUB ELAGANCIA 180X80cm	20	185X85	6/13	16
BATHTUB ELAGANCIA 190X90cm	20	195X95	6/12	14
BATHTUBS ORCHIDEA				
BATHTUB ORCHIDEA 105X105cm	22	112X112	10/20	24
BATHTUB ORCHIDEA 120X120cm	23	125X125	4/8	12
BATHTUB ORCHIDEA 135X135cm	23	140X140	4/8	10
BATHTUB ORCHIDEA 140X140cm	23	145X145	4/8	9
BATHTUB ORCHIDEA 150X150cm	23	155X155	3/7	9
BATHTUBS ANTHEMIA				
BATHTUB ANTHEMIA 153X99cm L	23	160X105	7/14	16
BATHTUB ANTHEMIA 153X99cm R	23	160X105	7/14	16
BATHTUB ANTHEMIA 160X90cm L	23	165X95	6/14	16
BATHTUB ANTHEMIA 160X90cm R	23	165X95	6/14	16
BATHTUBS IRIDA				
BATHTUB IRIDA 170X75cm	22	175X80	7/14	22
BATHTUB IRIDA 180X80cm	23	185X85	6/13	16
BATHTUB IRIDA 190X90cm	23	195X95	6/12	14
BATHTUBS VALERIA				
BATHTUB VALERIA 120X70cm	23	125X75	13/27	31
BATHTUB VALERIA 140X70cm	23	145X75	12/24	27
BATHTUB VALERIA 150X70cm	23	155X75	10/22	25
BATHTUB VALERIA 160X70cm	23	165X75	10/21	24
BATHTUB VALERIA 170X70cm	23	175X75	9/19	22
BATHTUB VALERIA 170X75cm	23	175X80	7/14	22
BATHTUB VALERIA 170X80cm	23	175X85	6/13	16
BATHTUB VALERIA 180X80cm	23	185X85	6/13	16
BATHTUBS ANEMONA				
BATHTUB ANEMONA 120X70cm	23	125X75	13/27	31
BATHTUB ANEMONA 160X70cm	23	165X75	10/21	24
BATHTUB ANEMONA 170X70cm	23	175X75	9/19	22

BATHTUB PANELS	ITEMS PER PALLET	PALLET DIMENSIONS	PALLETS PER 20"/40" CONTAINER	PALLETS PER TRUCK
PANELS FOR ORCHIDEA				
PANEL FOR ORCHIDEA 105X105cm	25	180X60	9/19	22
PANEL FOR ORCHIDEA 120X120cm	25	180X60	9/19	22
PANEL FOR ORCHIDEA 135X135cm	25	180X60	9/19	22
PANEL FOR ORCHIDEA 140X140cm	25	180X60	9/19	22
PANEL FOR ORCHIDEA 150X150cm	25	180X60	9/19	22
PANELS FOR ANTHEMIA				
PANEL FOR ANTHEMIA 153X99cm REV	25	180X60	9/19	22
PANEL FOR ORCHIDEA 160X90cm REV	25	180X60	9/19	22

SANITARY WARE	ITEMS PER PALLET	PALLET DIMENSIONS	PALLETS PER 20"/40" CONTAINER	PALLETS PER TRUCK
DEKELIA				
WASHBASIN DEKELIA 600	12	120X80X130	11/23	66
PEDESTAL DEKELIA 600	30	120X80X130	11/23	66
SEMI PEDESTAL DEKELIA 600	18	120X80X125	11/23	66
WC DEKELIA LPP 655X355	9	120X80X147	11/23	33
CISTERN DEKELIA MECHANISM 3/6 LT PBI	24	120X80X105	22/46	66
SEAT & COVER DEKELIA SOFT CLOSE	72	120X80X110	22/46	66
ERETRIA				
WASHBASIN ERETRIA COUNTERTOP 450X450	20	120X95X120	10/21	56
WASHBASIN ERETRIA COUNTERTOP 600X450	16	120X95X110	20/42	56
WC ERETRIA BTW LPP 670X340	9	120X80X147	11/23	33
CISTERN ERETRIA MECHANISM 3/6 LT PBI	24	120X80X105	22/46	66
SEAT & COVER ERETRIA SOFT CLOSE	72	120X80X110	22/46	66
WC ERETRIA WALL HUNG 520X355	9	120X80X147	11/23	33
ETOLIA - LIDIA - ACTIUM				
WASHBASIN ETOLIA 800X500	10	120X80X105	22/46	66
WASHBASIN LIDIA 500X500	12	120X80X130	11/23	66
WASHBASIN ACTIUM 800X410	10	120X80X105	22/46	66
ELATIA				
WASHBASIN ELATIA BOWL COUNTERTOP 450	20	120X95X120	10/21	56
WASHBASIN ELATIA 450	20	120X95X120	10/21	56
SEMI PEDESTAL ELATIA 450	30	120X80X130	11/23	66
WASHBASIN ELATIA 600	12	120X80X130	11/23	66
PEDESTAL ELATIA 600	30	120X80X130	11/23	66
SEMI PEDESTAL ELATIA 600	18	120X80X125	11/23	66
WC ELATIA 610X350	9	120X80X147	11/23	66
CISTERN ELATIA MECHANISM 3/6 LT PBI	24	120X80X105	22/46	66
SEAT & COVER ELATIA	72	120X80X110	22/46	66
SEAT & COVER SOFT CLOSE	72	120X80X110	22/46	66
MILITOS				
WASHBASIN MILITOS 600	12	120X80X130	11/23	66
PEDESTAL MILITOS 600	30	120X80X130	11/23	66
WC MILITOS LPP 690X350	9	120X80X147	11/23	33
CISTERN MILITOS MECHANISM START - STOP 3/8 BI	24	120X80X105	22/46	66
SEAT & COVER MILITOS	72	120X80X110	22/46	66
SEAT & COVER MILITOS SOFT CLOSE	72	120X80X110	22/46	66
TROY				
WASHBASIN TROY 560	32	120X95X120	10/21	56
PEDESTAL TROY 560	40	120X95X90	20/42	56
WC TROY LPP 665X350	30	120X95X170	10/21	28
CISTERN TROY SQ MECHANISM NP BI	20	120X80X90	22/46	66
SEAT & COVER TROY	72	120X80X110	22/46	66
WASHBANS UNDERMOUNT & INSET				
WASHBASIN UNDERCOUNTER 530	12	120X80X120	11/23	66
WASHBASIN UNDERCOUNTER 580	12	120X80X120	11/23	66
WASHBASIN COUNTERTOP 600	12	120X80X130	11/23	66
WCs & URINAL				
WC HIGH PRESSURE P 460X350	24	120X115X130	8/18	44
SEAT & COVER TROY	72	120X80X110	22/46	66
WC WALL HUNG 515X350	16	120X80X120	11/23	66
SEAT & COVER TROY WALL HUNG WC	72	120X80X110	22/46	66
URINAL CONSEALED OUTLET BI 550X360	8	120X80X105	22/46	66

TAPS	ITEMS PER CARTON	CARTONS PER PALLET	PALLET DIMENSIONS	PALLETS PER 20"/40" CONTAINER	PALLETS PER TRUCK
BATHROOM TAPS					
STRETO WASHBASIN TAP XL	6 ITEMS / CARTON BOX	24	80X120X165	11/23	33
STRETO WASHBASIN TAP	6 ITEMS / CARTON BOX	24	80X120X165	11/23	33
STRETO SHOWER RAIL	6 ITEMS / CARTON BOX	24	80X120X165	11/23	33
STRETO SHOWER	3 ITEMS / CARTON BOX	24	80X120X165	11/23	33
STRETO SHOWER WITHOUT SHOWER KIT	3 ITEMS / CARTON BOX	24	80X120X165	11/23	33
ELEGATO WASHBASIN	6 ITEMS / CARTON BOX	24	80X120X165	11/23	33
ELEGATO SHOWER	6 ITEMS / CARTON BOX	24	80X120X165	11/23	33
MATINATA WASHBASIN	6 ITEMS / CARTON BOX	24	80X120X165	11/23	33
MATINATA SHOWER	3 ITEMS / CARTON BOX	24	80X120X165	11/23	33
VISCARIA WASHBASIN TAP	3 ITEMS / CARTON BOX	24	80X120X165	11/23	33
VISCARIA SHOWER RAIL	1 ITEM / CARTON BOX	26	110X130X180	9/19	22
VISCARIA SHOWER WITHOUT SHOWER KIT	3 ITEMS / CARTON BOX	24	80X120X165	11/23	33
ROTA WASHBASIN TAP	6 ITEMS / CARTON BOX	24	80X120X165	11/23	33
ROTA WASHBASIN TAP XL	6 ITEMS / CARTON BOX	24	80X120X165	11/23	33
ROTA SHOWER	3 ITEMS / CARTON BOX	24	80X120X165	11/23	33
RUSTICO WASHBASIN TAP	6 ITEMS / CARTON BOX	24	80X120X165	11/23	33
RUSTICO SHOWER	6 ITEMS / CARTON BOX	18	80X120X165	11/23	33
CANTANDO WASHBASIN TAP	12 ITEMS / CARTON BOX	18	80X120X165	11/23	33
CANTANDO SHOWER	6 ITEMS / CARTON BOX	24	80X120X165	11/23	33
SOLFEGIO WASHBASIN TAP	20 ITEMS / CARTON BOX	36	100X120X140	9/20	26
SOLFEGIO SHOWER	12 ITEMS / CARTON BOX	12	100X80X140	14/28	34
WASHBASINS					
BOLERO	1 ITEM / CARTON BOX	52	100X120	9/20	26
RAVEL	1 ITEM / CARTON BOX	52	100X120	9/20	26

WATERHEATERS	ITEMS PER PALLET	PALLET DIMENSIONS	PALLETS PER 20"/40" CONTAINER	PALLETS PER TRUCK
SOLAR SYSTEMS				
BOILER 120 LT	6-CONTAINER / 8-TRUCK	105X120X255	8/18	24
BOILER 160 LT	6-CONTAINER / 8-TRUCK	120X120X255	4/9	22
BOILER 200 LT	6-CONTAINER / 8-TRUCK	135X120X255	4/9	20
COLLECTOR 1,5m ²	13	120X80X165	11/23	33
COLLECTOR 2m ²	13	120X80X215	11/23	33
WATERHEATERS				
WATERHEATER 10 LT	56	80X120X180	11/23	33
WATERHEATER 25 LT	20	80X120X210	11/23	33
WATERHEATER 40 LT	20	90X130X210	10/22	25
WATERHEATER 60 LT	12	80X145X210	11/22	24
WATERHEATER 80 LT	12	90X145X210	8/16	24
WATERHEATER 100 LT	12	110X145X210	8/16	18
WATERHEATER 120 LT	12	130X145X210	4/8	9

Handwriting practice lines consisting of a top header line, a series of 20 horizontal lines, and a bottom footer line.

Handwriting practice lines consisting of a top header line, a series of 20 horizontal lines, and a bottom footer line.

Handwriting practice lines consisting of a top header line, a bottom footer line, and 28 horizontal lines in between, all with rounded ends.



PYRAMIS METALLOURGIA A.E.

17th km Thessaloniki-Serres
P.O. Box 10 278
54110, Thessaloniki
Greece

Tel.: +30 23940 56751
Fax.: +30 23940 56745

exportsales@pyramis.gr
www.pyramisgroup.com